

Synaptic Plasticity : Spike-timing dependent plasticity (STDP)

Oct 10th, 2017

Michael Graupner

michael.graupner@parisdescartes.fr

CNRS UMR 8118 - Université Paris Descartes

slides : <http://www.biomedicale.univ-paris5.fr/~mgraupne/>



Synaptic Plasticity : Spike-timing dependent plasticity (STDP)

Oct 10th, 2017

Michael Graupner

michael.graupner@parisdescartes.fr

CNRS UMR 8118 - Université Paris Descartes

slides : <http://www.biomedicale.univ->

[paris5.fr/~mgraupne/](http://www.biomedicale.univ-paris5.fr/~mgraupne/)



UNIVERSITÉ
PARIS
DESCARTES

A white line-art illustration of a human brain, showing the intricate folds and grooves of the cerebral cortex. The brain is centered on a solid blue background. A semi-transparent grey rectangular box is overlaid on the brain, containing the text.

At which university am I working ?



At which university am I working ?

→ synaptic plasticity basis of learning

Why are we interested in synaptic plasticity ?

Morris water maze

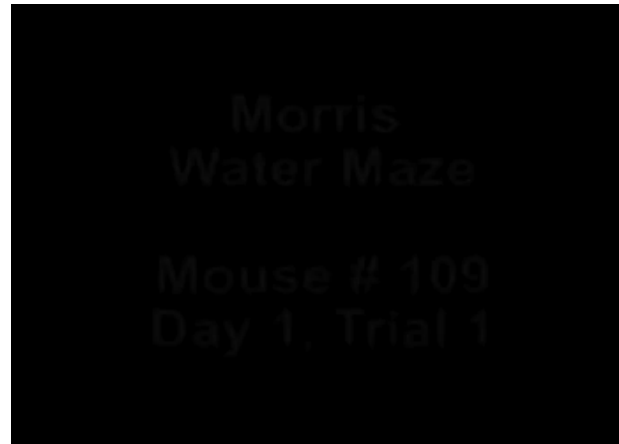

[Morris *et al.*, 1986]

Relation between LTP and learning/memory

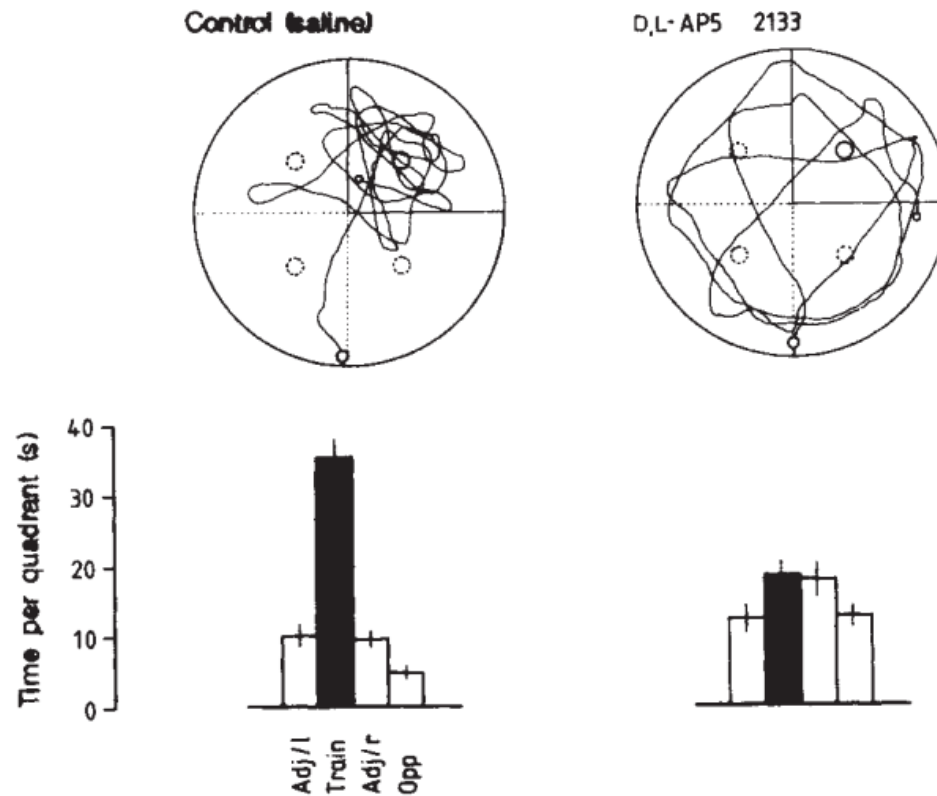

- NMDA receptor required to learn platform location [Morris *et al.*, 1986]
- NMDA receptor required to form spatial memories (place fields) [McHugh *et al.* 1996]

Outline : STDP ... spike-timing dependent plasticity

1. STDP : introduction and history
2. Phenomenology of STDP
3. Induction mechanisms
4. Biophysical models of STDP
5. STDP *in vivo*

Outline

1. STDP : introduction and history
2. Phenomenology of STDP
3. Induction mechanisms
4. Biophysical models of STDP
5. STDP *in vivo*

Chemical synapse : transmits electrical signals

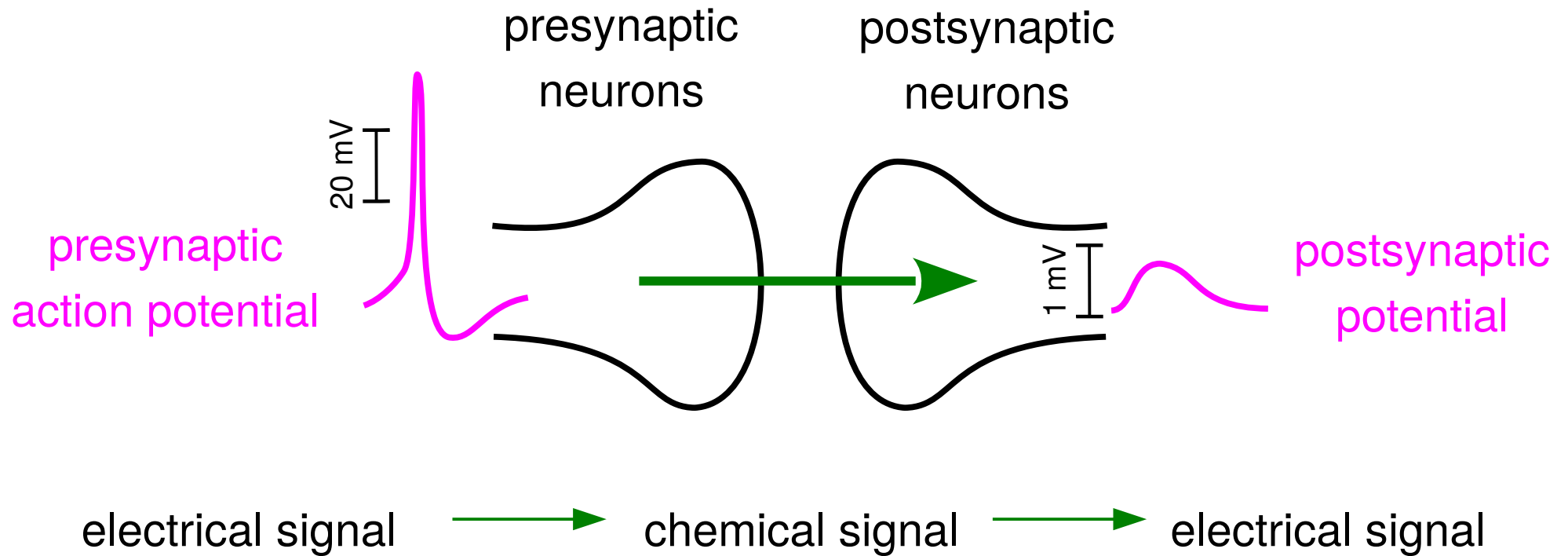

- directional transmission
- conversion of signals allows for flexibility/plasticity

Chemical synapse : underlying biological machinery

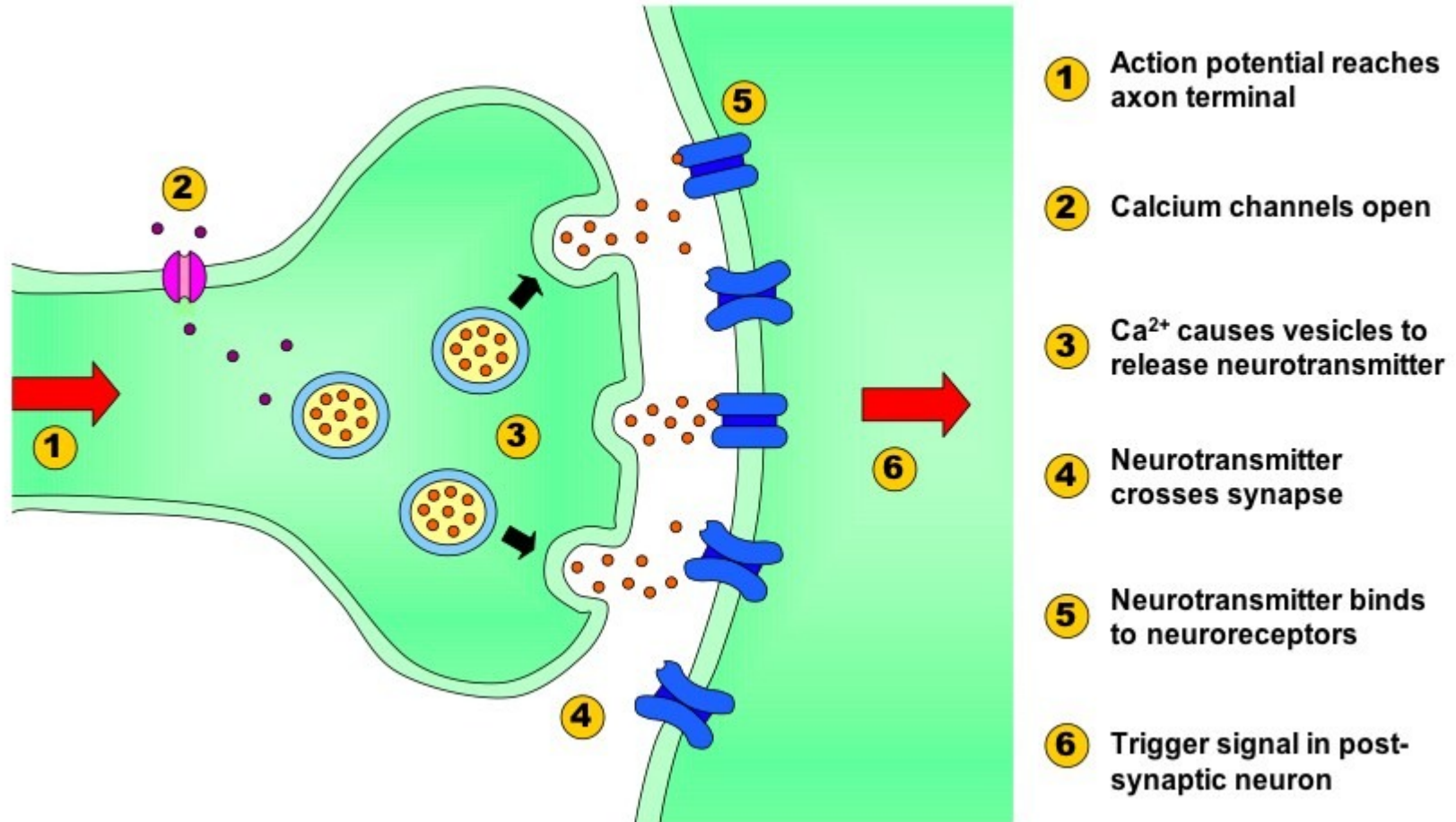

Chemical synapse : excitatory or inhibitory

Excitatory synapse

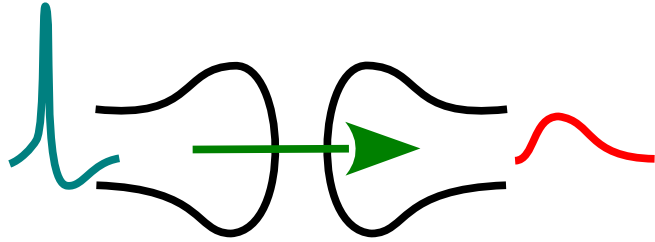

depolarization:
excitatory postsynaptic potential (EPSP)

neurotransmitter	receptor
glutamate	AMPA, NMDA
acetylcholine	nAChR, mAChR
catecholamines	G-protein-coupled receptors
serotonin	5-HT ₃ , ...
histamine	G-protein-coupled receptors

Inhibitory synapse

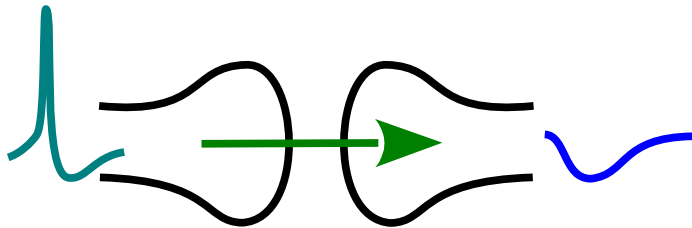

hyperpolarization:
Inhibitory postsynaptic potential (IPSP)

neurotransmitter	receptor
GABA	GABA _A , GABA _B
glycine	GlyR

Different forms of plasticity

structure of neurons

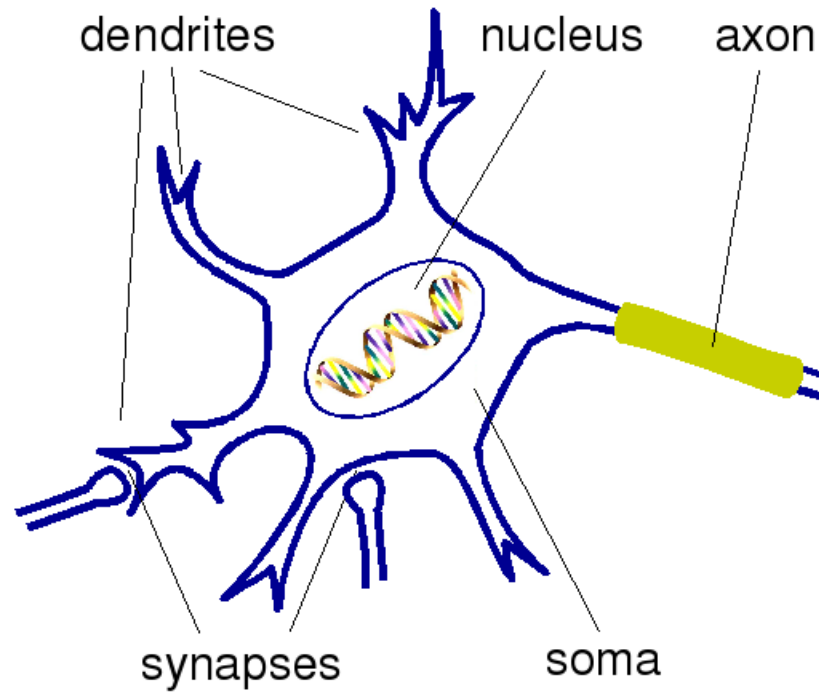

changes related to neural activity

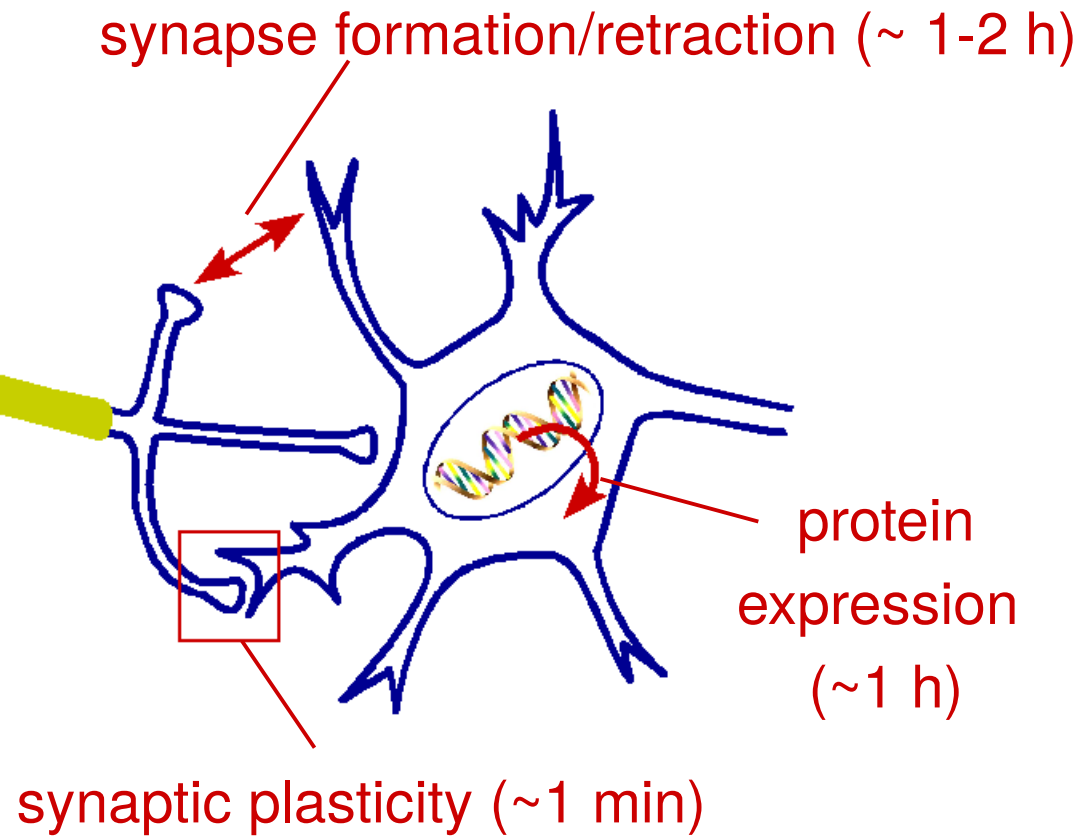

Short-term synaptic plasticity

train of presynaptic
action potentials

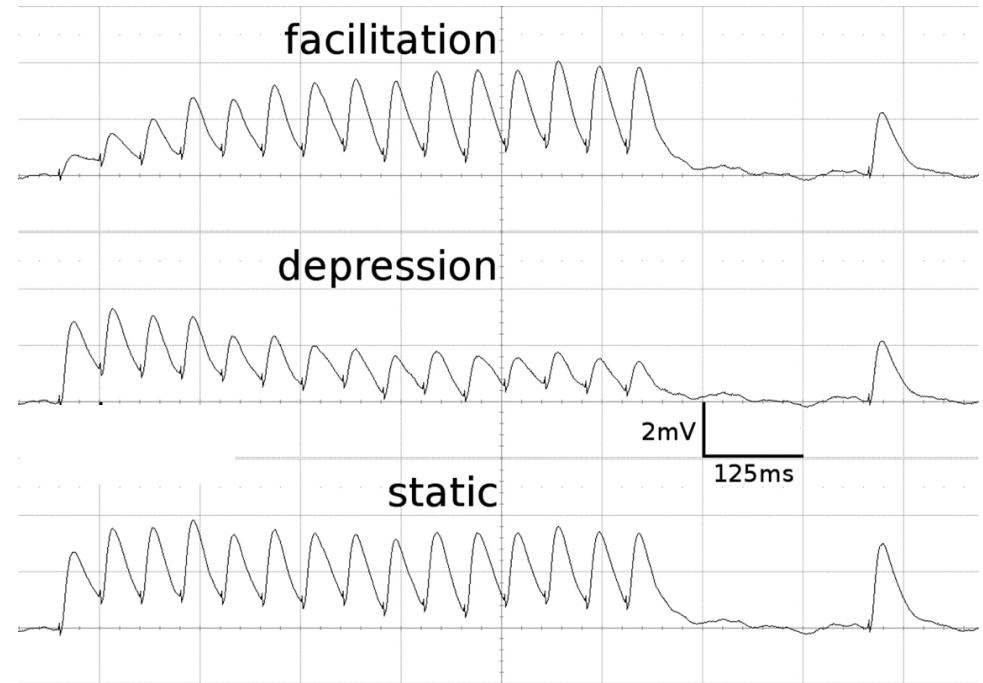
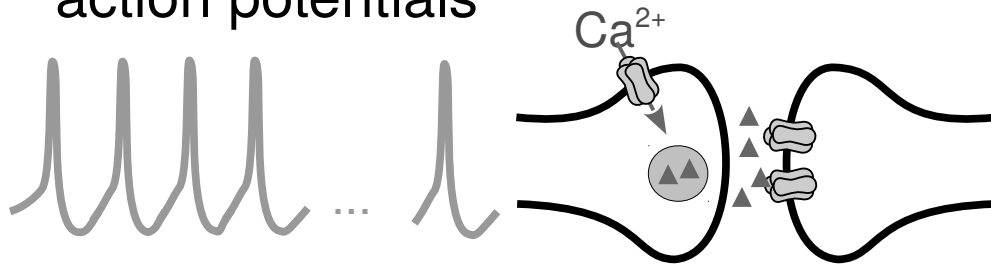

- transient change in transmission efficacy
- time scale of changes ~ 1 sec

Long-term synaptic plasticity

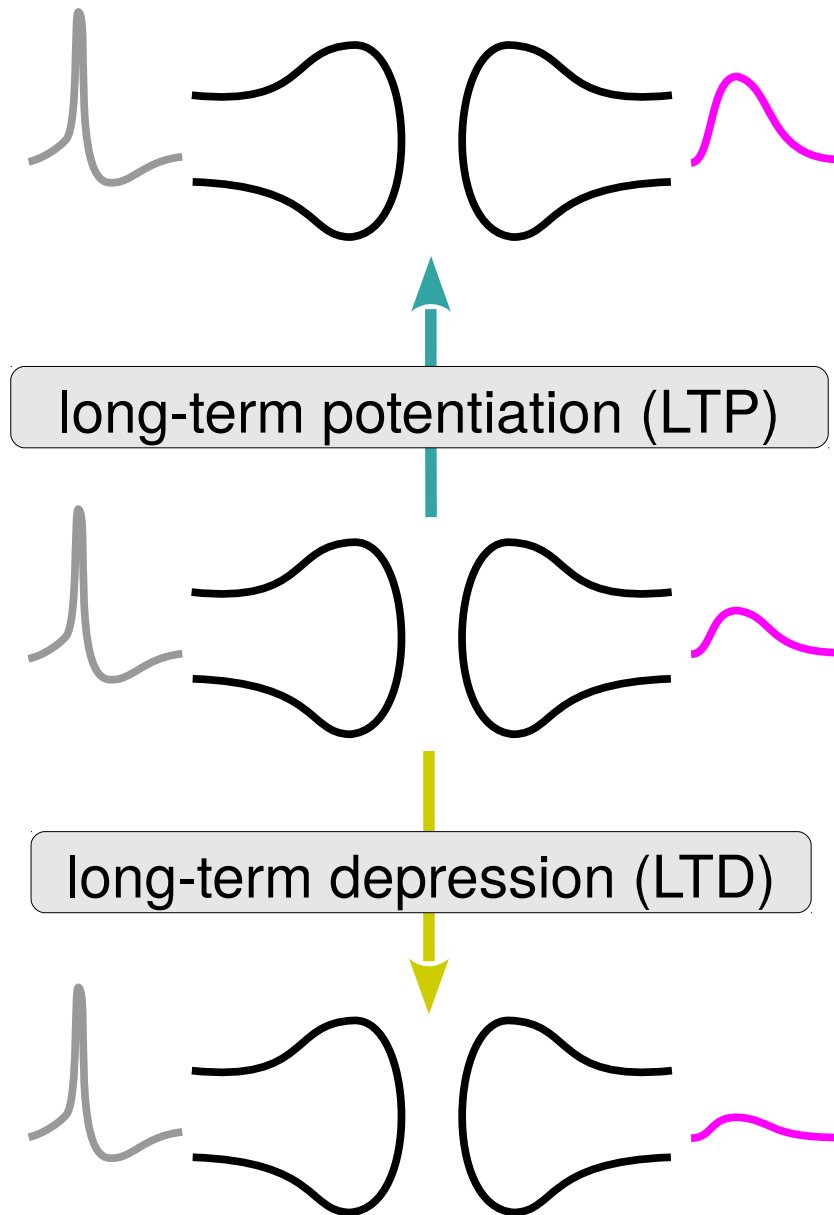

- long-lasting change (>60 min) in transmission efficacy
- time scale of induction ~ 1 min

Synaptic plasticity: induction, maintenance & states

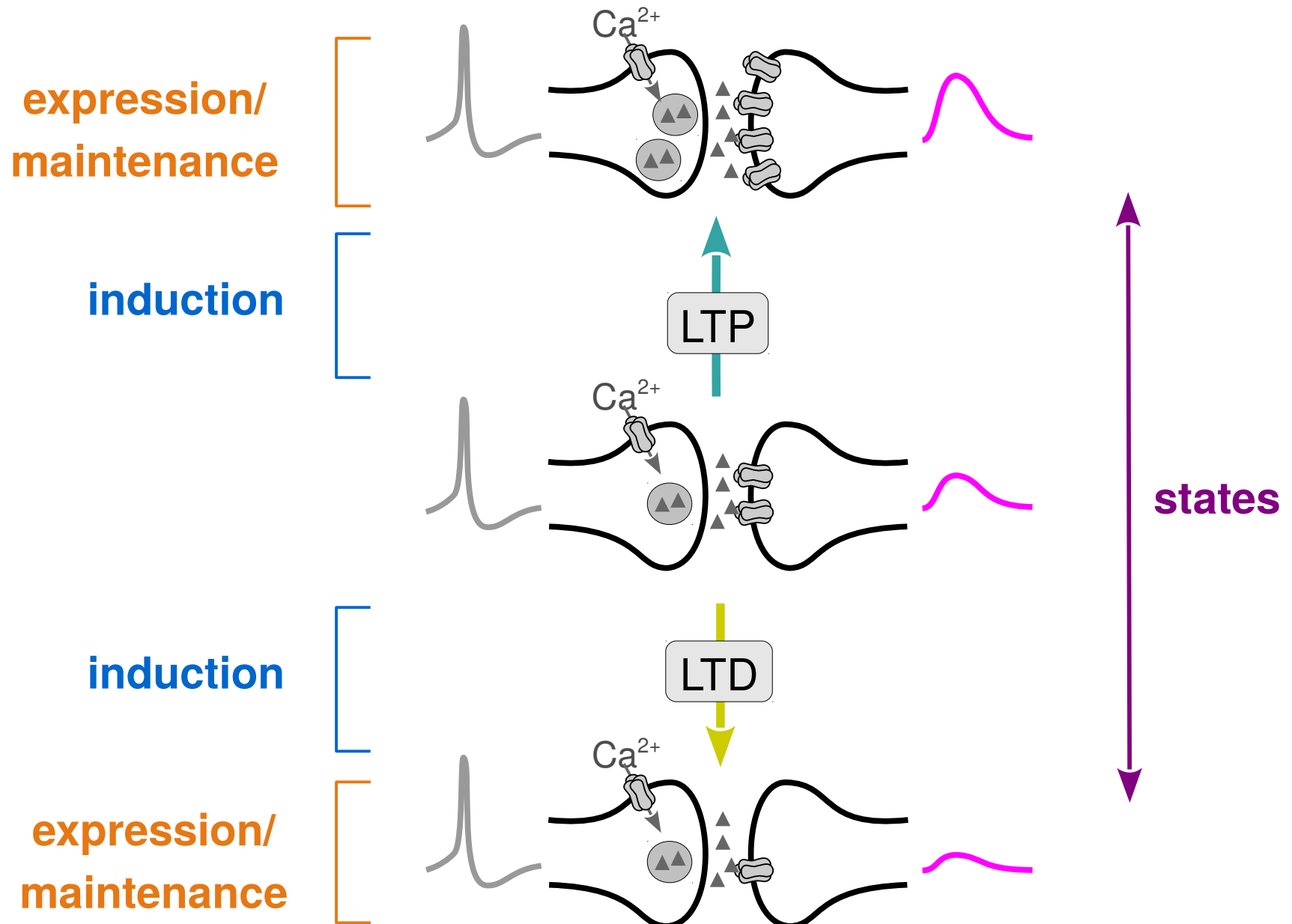

Spike timing : nomenclature

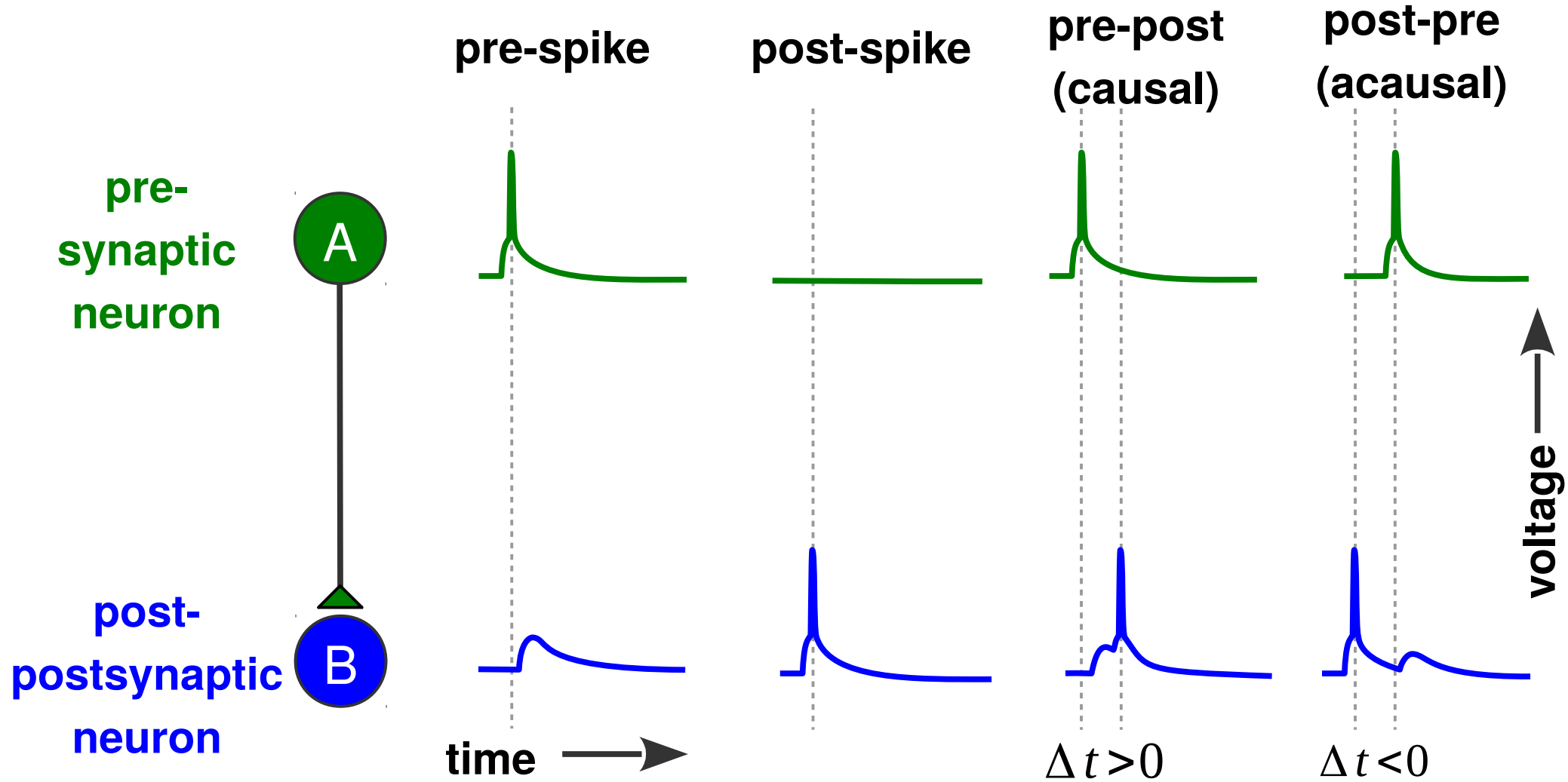

Spike timing : nomenclature

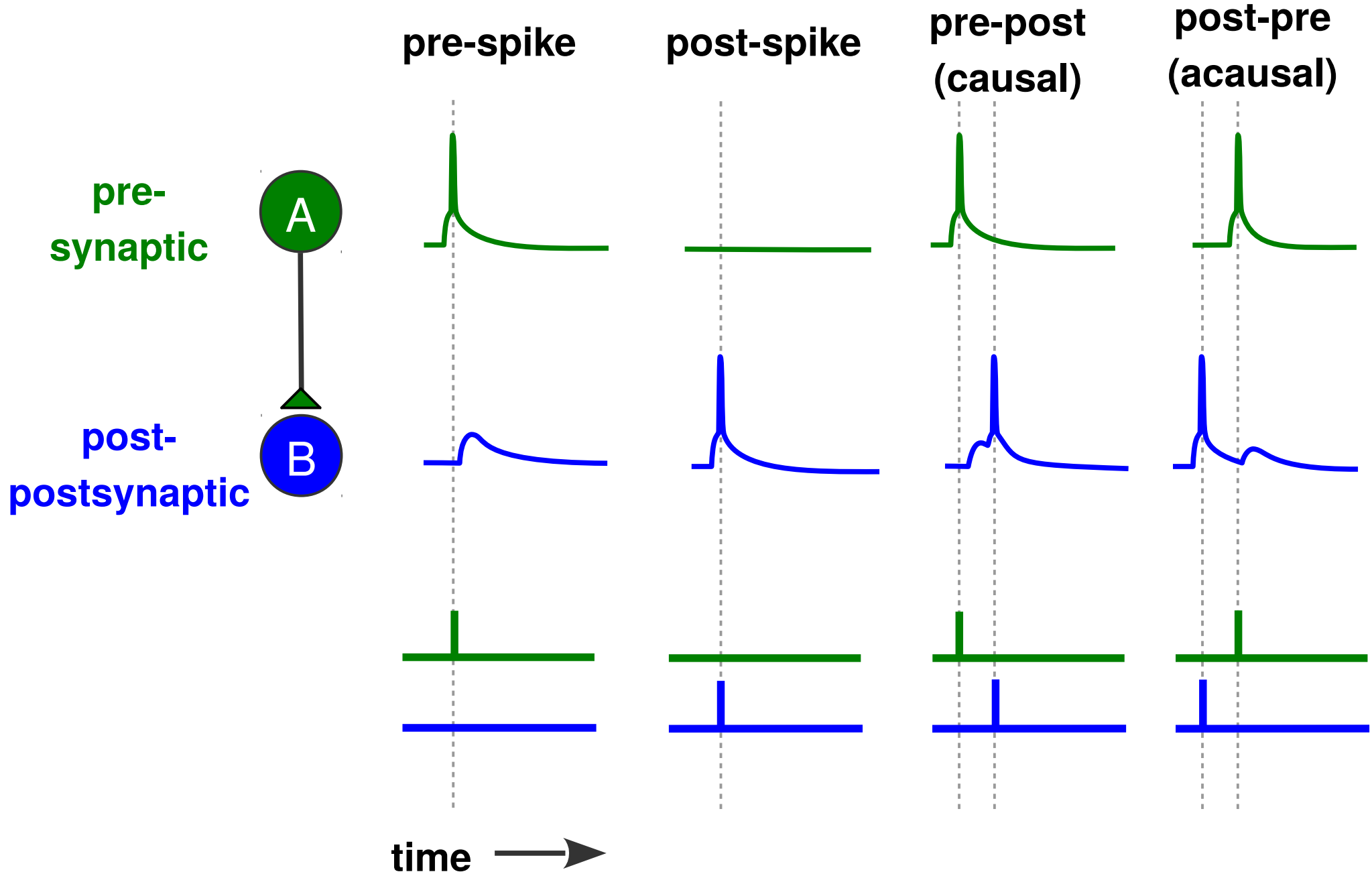

LTP induction: early conceptual work

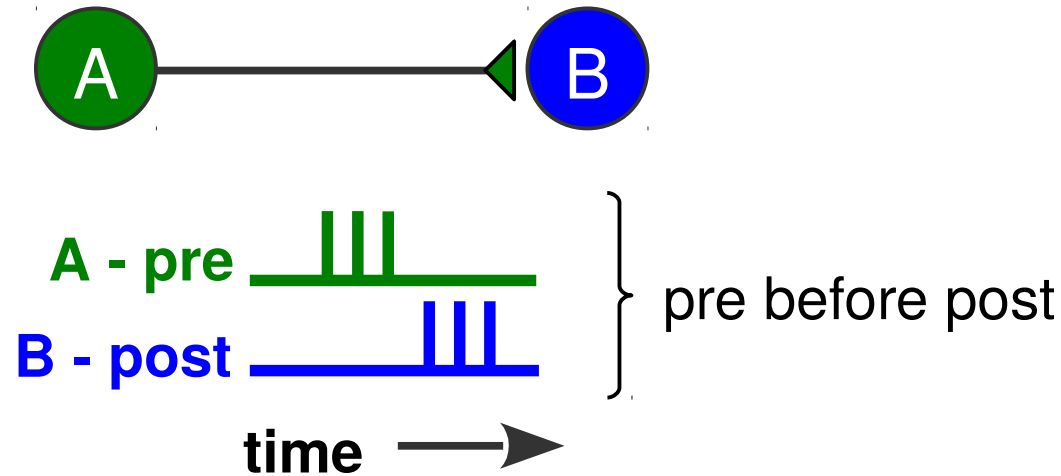

“When an axon of cell A is near enough to excite a cell B and *repeatedly and persistently* takes part in firing it, some growth or metabolic changes take place in one or both cells such that A’s efficiency, as one of the cells firing B, is *increased*.”

[Hebb 1949;
see also Konorski 1948]

Induction: first experimental work in hippocampus

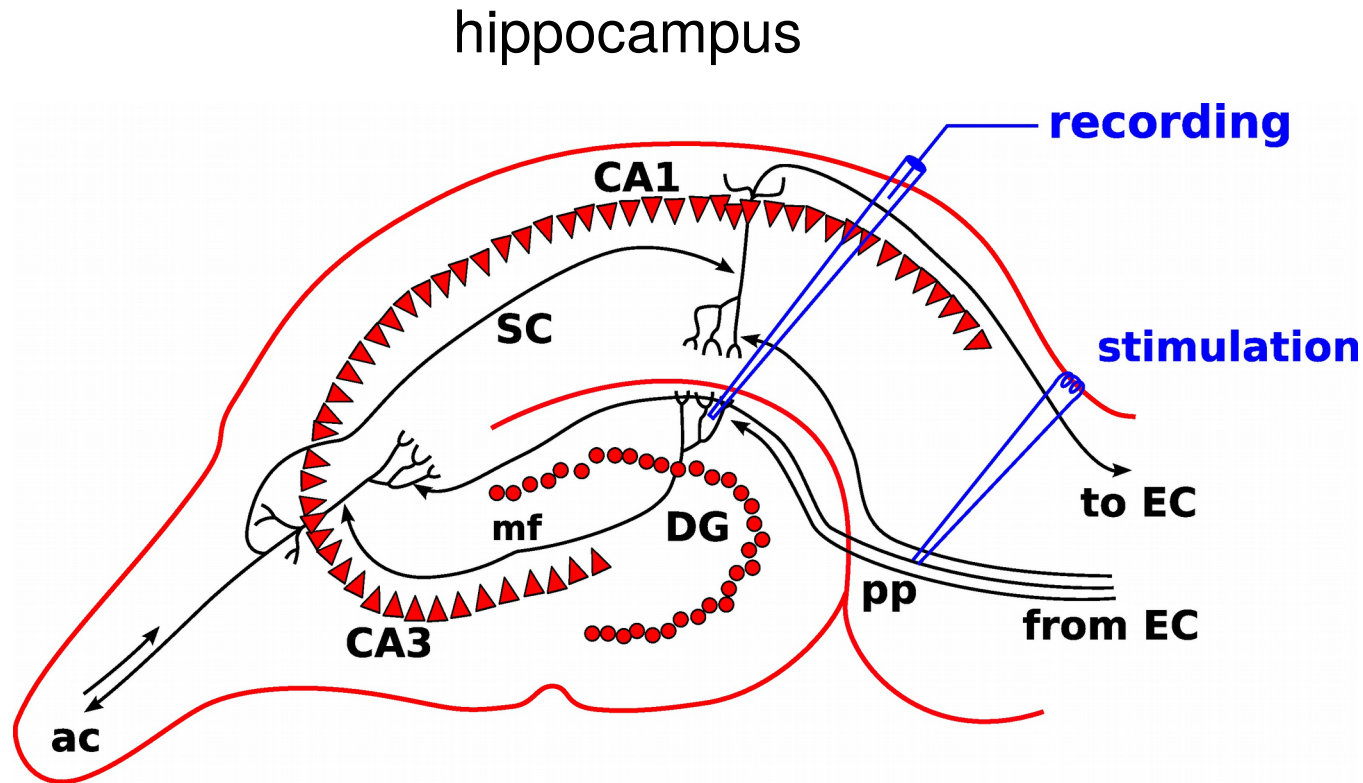

EC ... enthorhinal cortex
DG ... dentate gyrus
CA3/1 ... cornu ammonis 3/1



pp ... perforant path
mf ... mossy fibres
ac ... associational commissural path
sc ... Schaffer collateral

1. STDP : introduction and history

Induction: LTP through high frequency stimulation

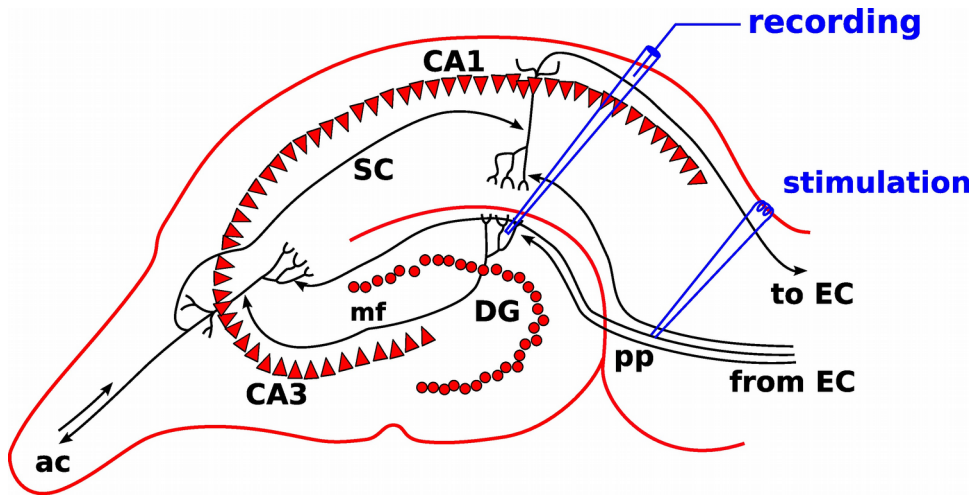
hippocampus (*in vivo*)



pre  10-20 Hz for 10-15 sec
post  or 100 Hz for 3-4 sec

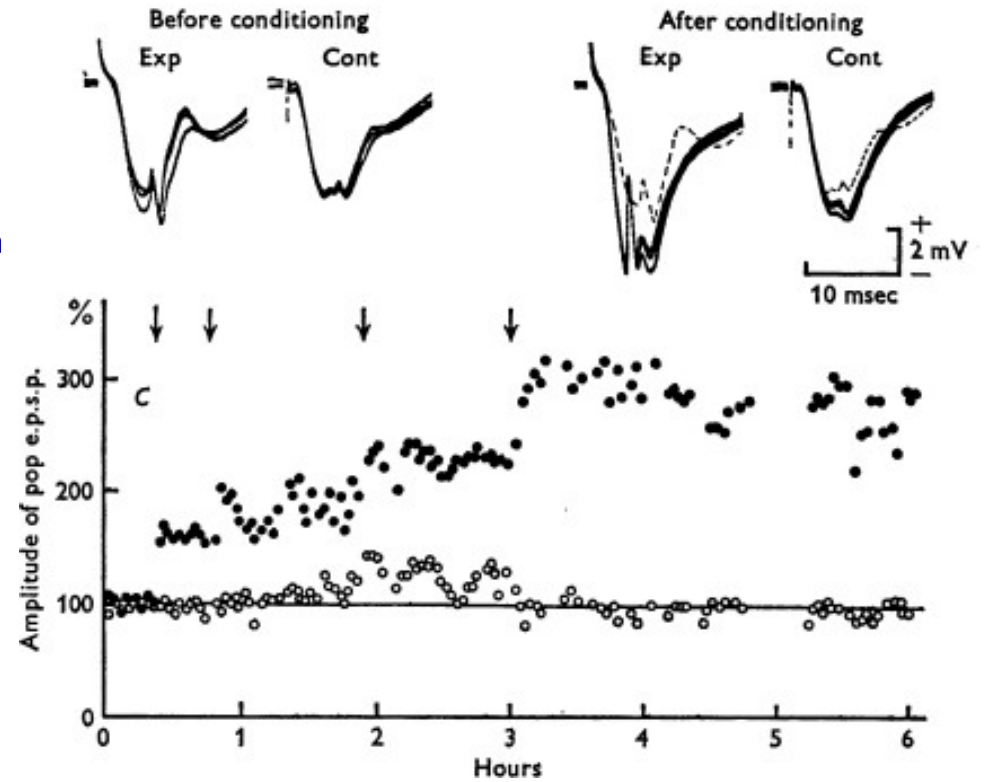

[Bliss and Lomo 1973]

LTD induction: postulate of Stent

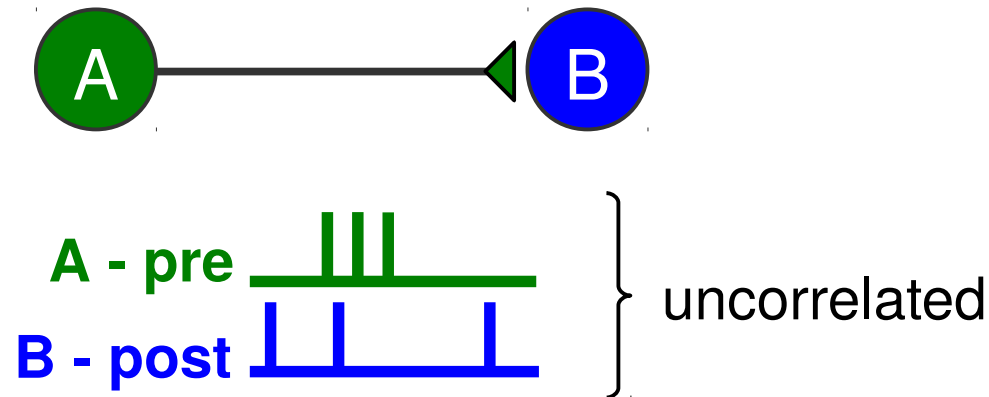

“When the presynaptic axon of cell *A* *repeatedly* and *persistently* fails to excite the postsynaptic cell *B* while cell *B* is firing under the influence of other presynaptic axons, metabolic change takes place in one or both cells such that *A*’s efficiency, as one of the cells firing *B*, is *decreased*.”

[G. Stent 1973;
see also Sejnowski 1977, von der Malsburg 1973, Bienenstock et al. 1982]

Plasticity induction: LTD obtained at low frequencies

hippocampus (slices)

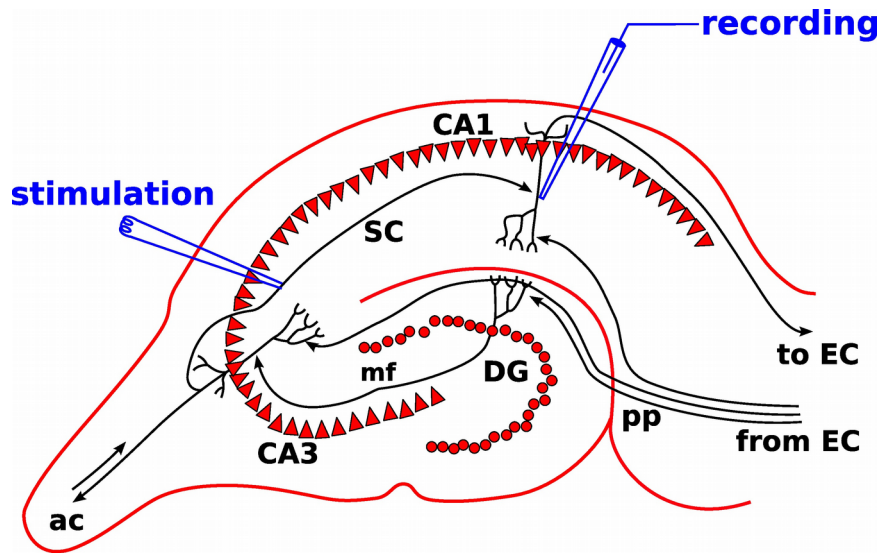

900 pulses at 1-50 Hz

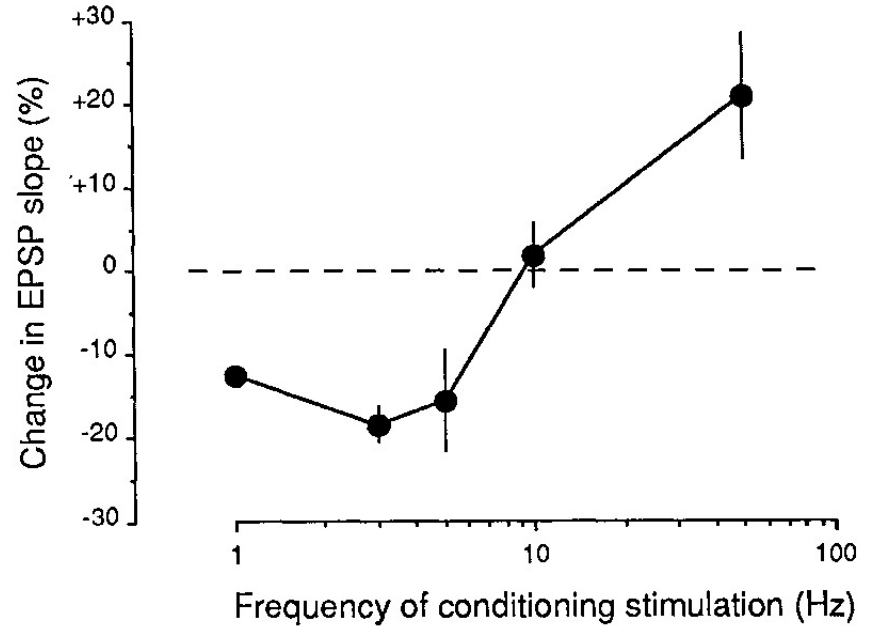

[Dudek and Bear 1992;
Dunwiddie and Lynch 1978]

STDP : plasticity from single spike-pairs

hippocampal cultures

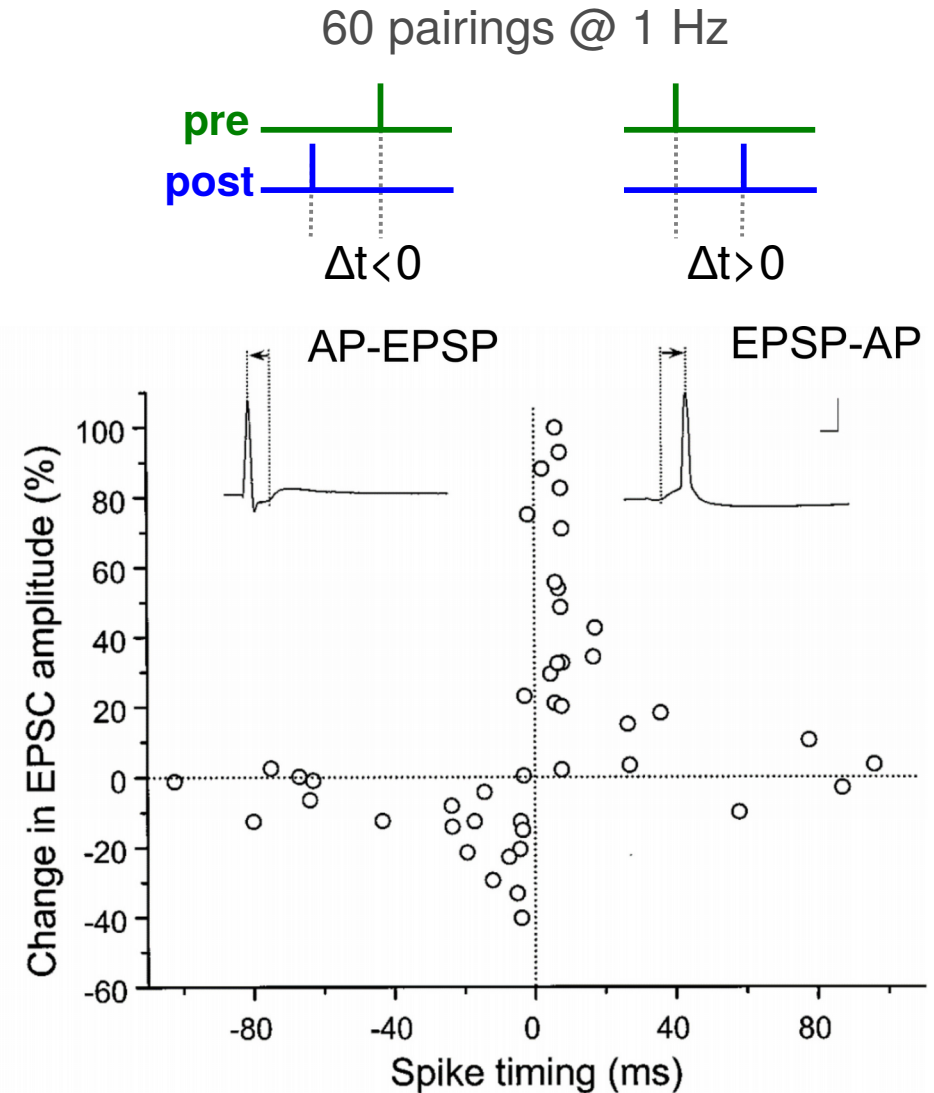
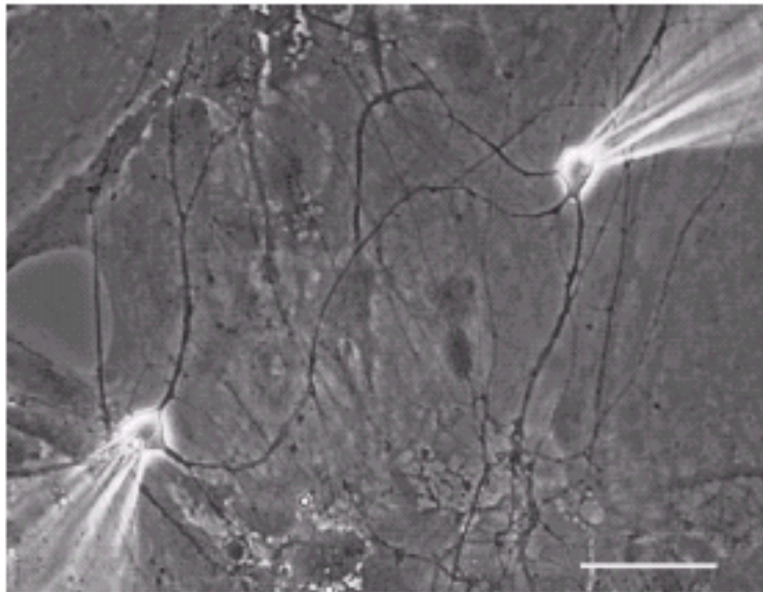

[Bi & Poo, J Neurosci 1998]

Frequency-dependent plasticity and STDP

frequency-dependent plasticity



900 pulses at 1-100 Hz

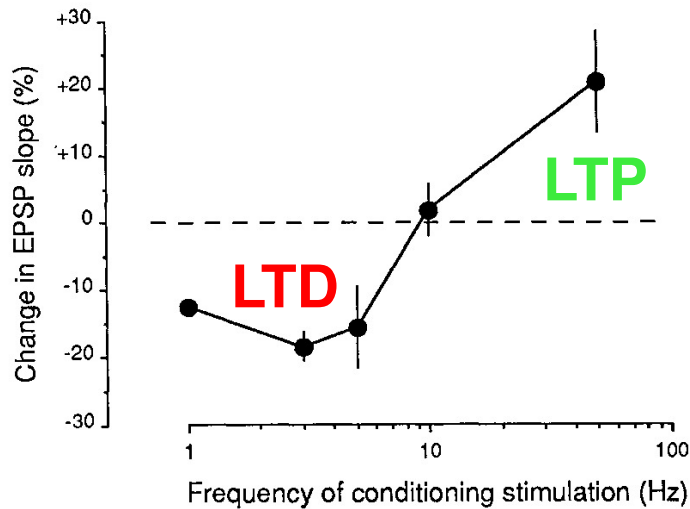

[Dudek and Bear 1992;
Dunwiddie and Lynch 1978]

spike timing-dependent plasticity



60 pairings @ 1 Hz

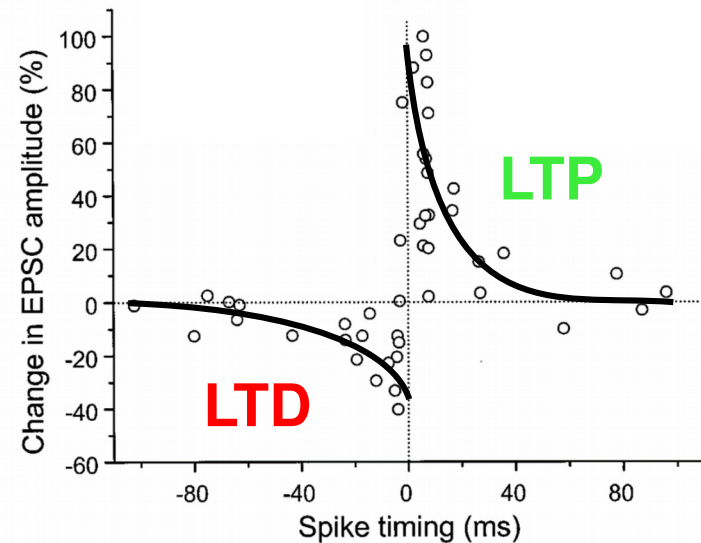

[Markram et al. 1997; Bi & Poo 1998;
Zhang et al. 1998]

Outline

1. STDP : introduction and history
- 2. Phenomenology of STDP**
3. Induction mechanisms
4. Biophysical models of STDP
5. STDP *in vivo*

Number of pairing

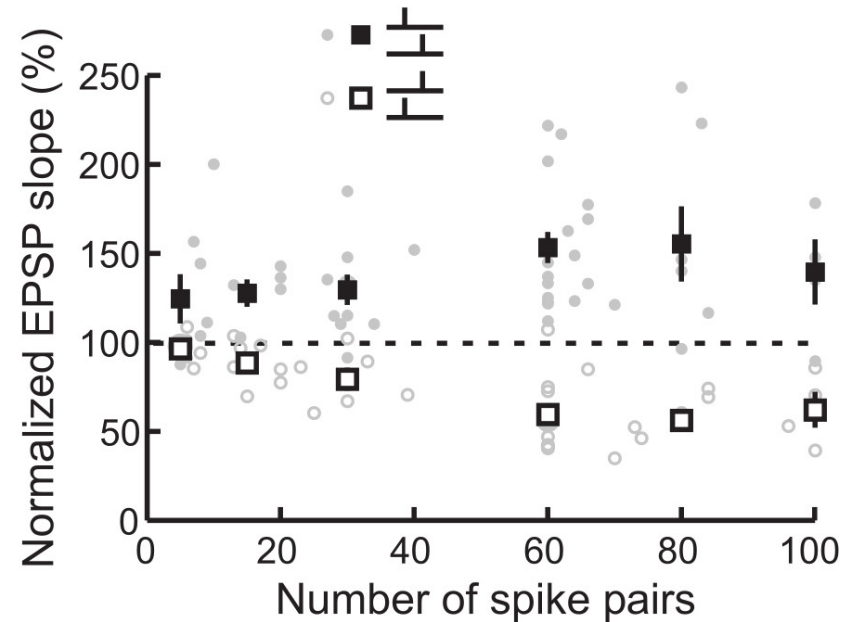
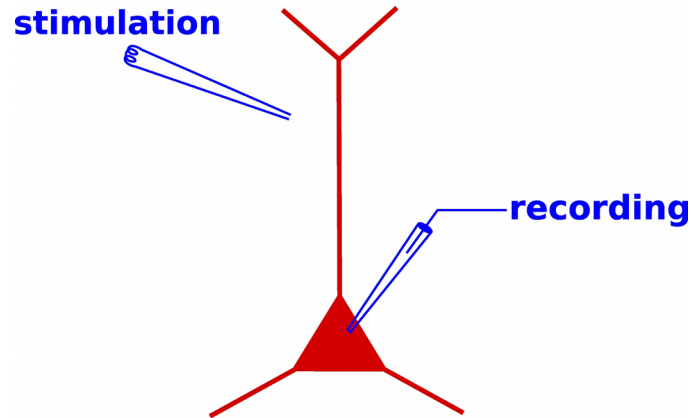

[Froemke et al. 2006]

- LTP induced with a few pairs
- LTD requires the presentation of ~20 stimulation pairs

Role of synaptic inhibition

control
→ no plasticity

inhibition blocked
→ LTP

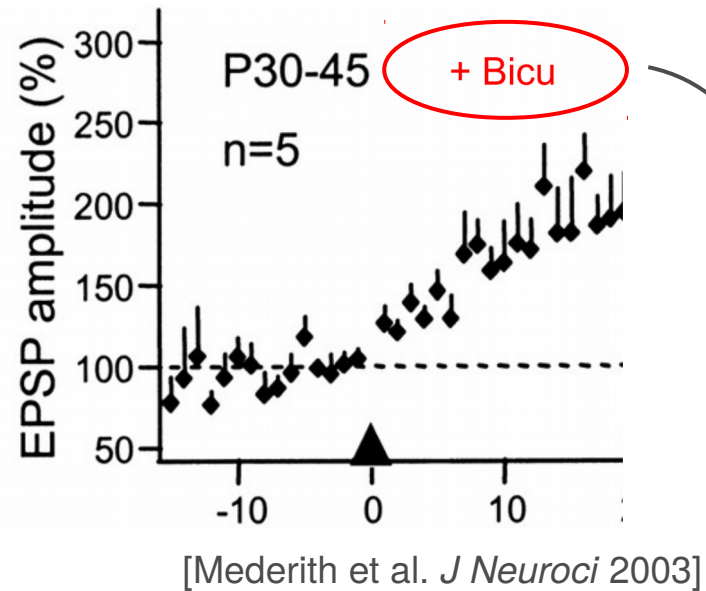
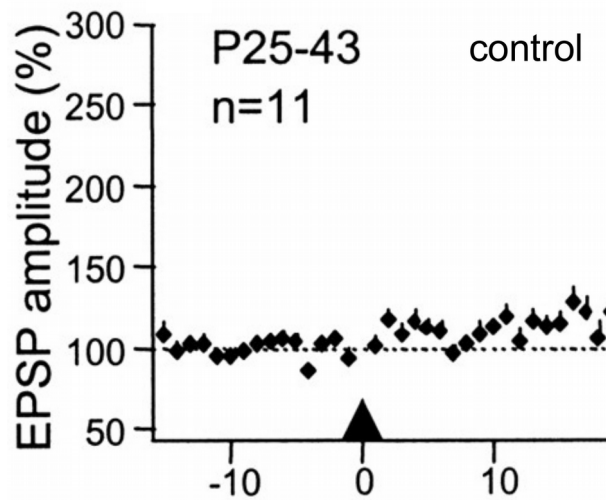

Bicuculline is a competitive antagonist of GABA_A receptors.

Role of synaptic inhibition

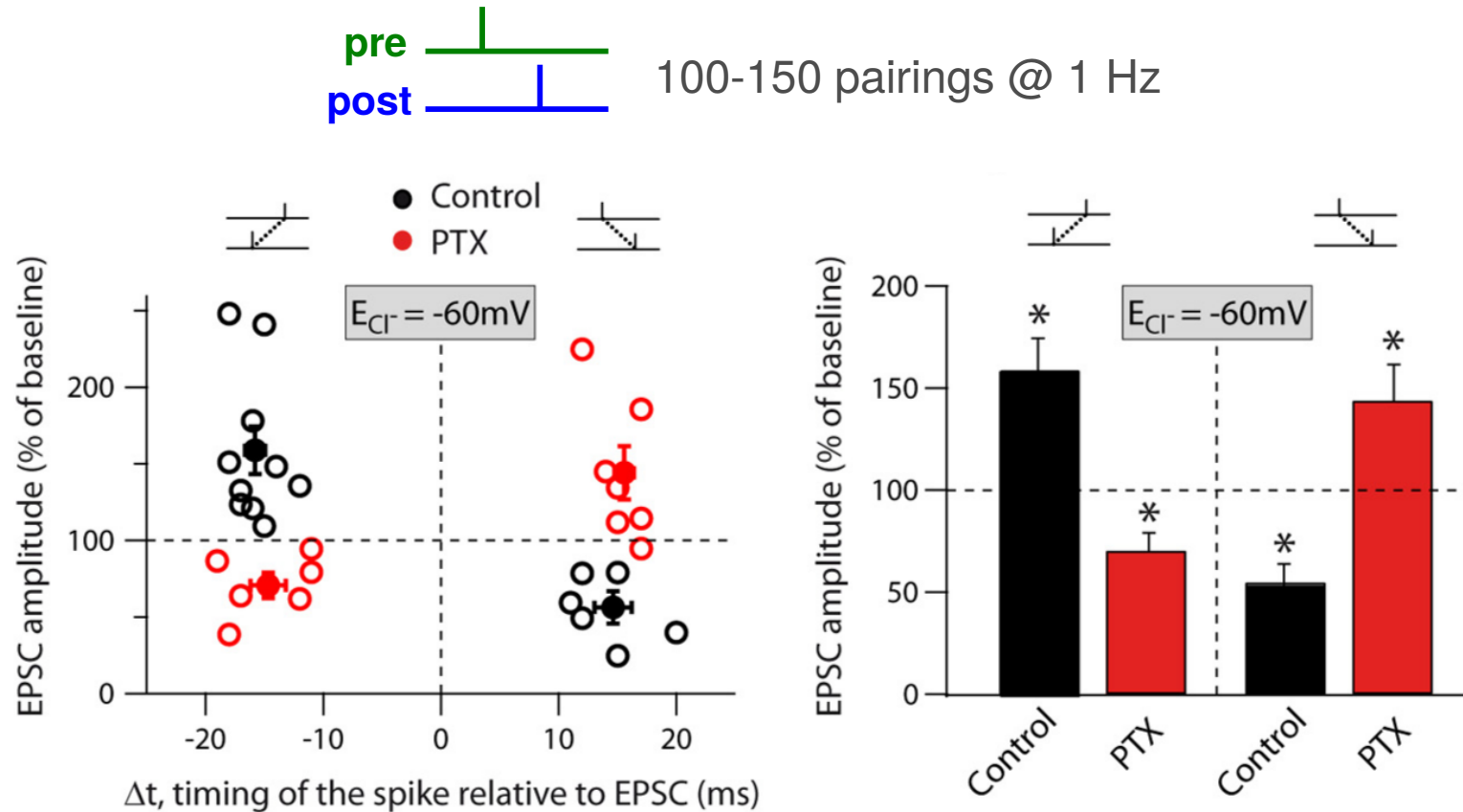

[Paille et al. *J Neurosci* 2013]

- inhibition inverts the STDP curve

Role of neuromodulation - Dopamine

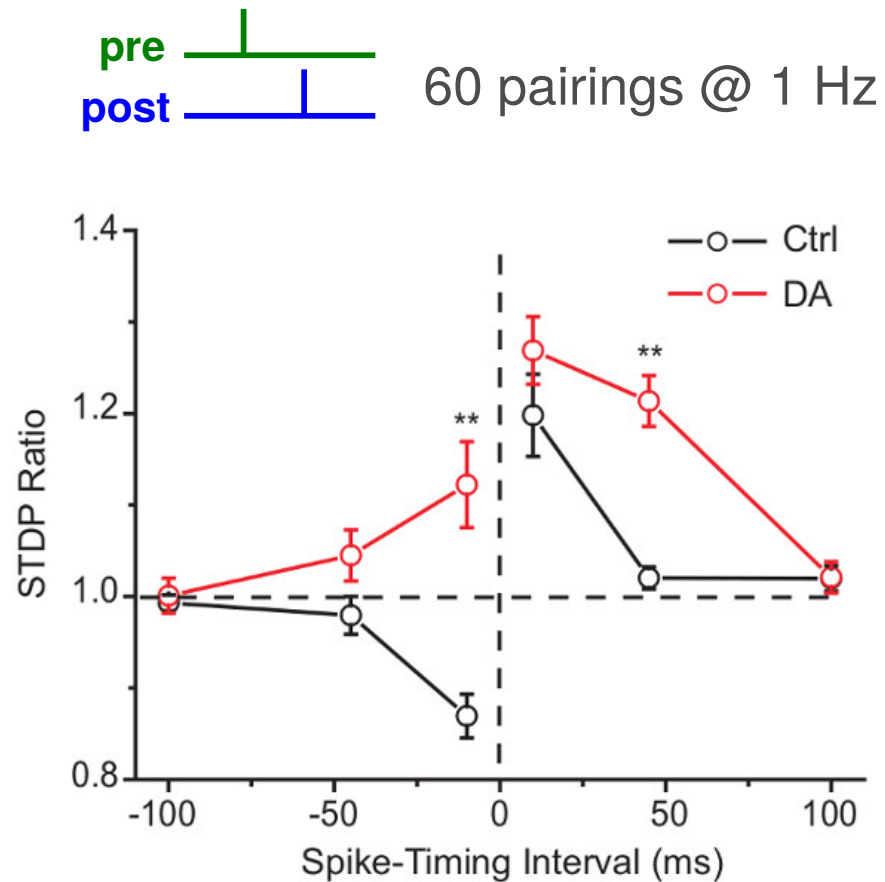

[Zhang et al. *PNAS* 2009]

- dopamine controls sign and magnitude of plasticity

STDP depends on frequency of spike-pairs

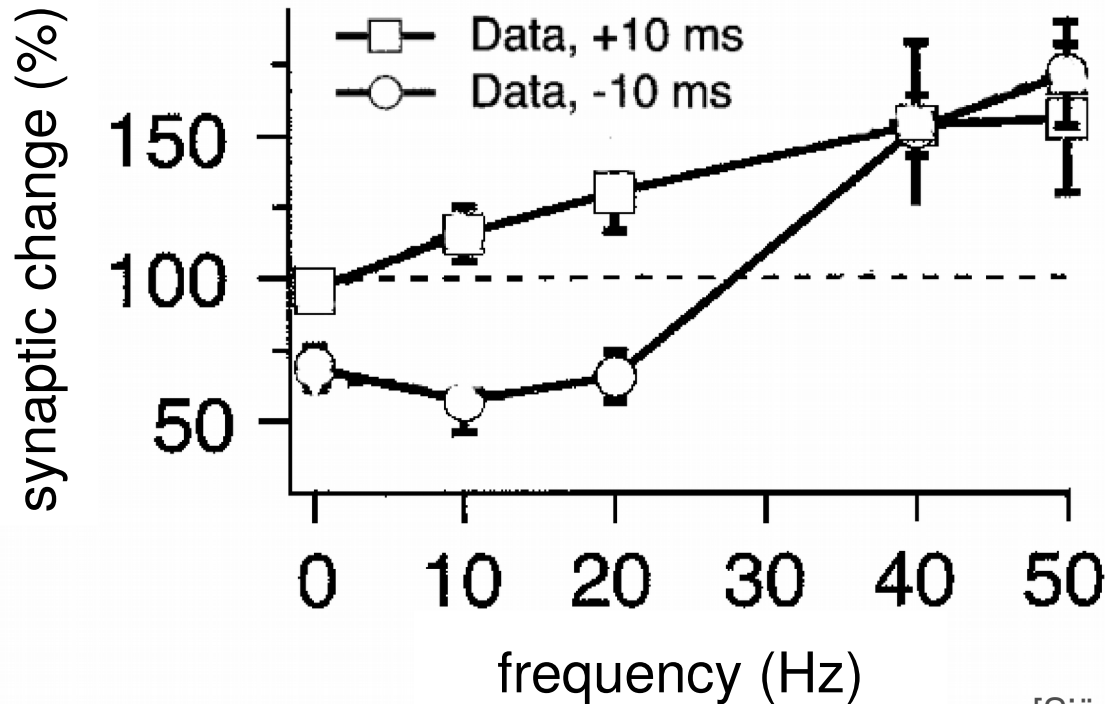

[Sjöström et al. *Neuron* 2001]

- post-pre pairings induce LTD at low and LTP at high frequencies

Non-linearity in STDP induction protocols

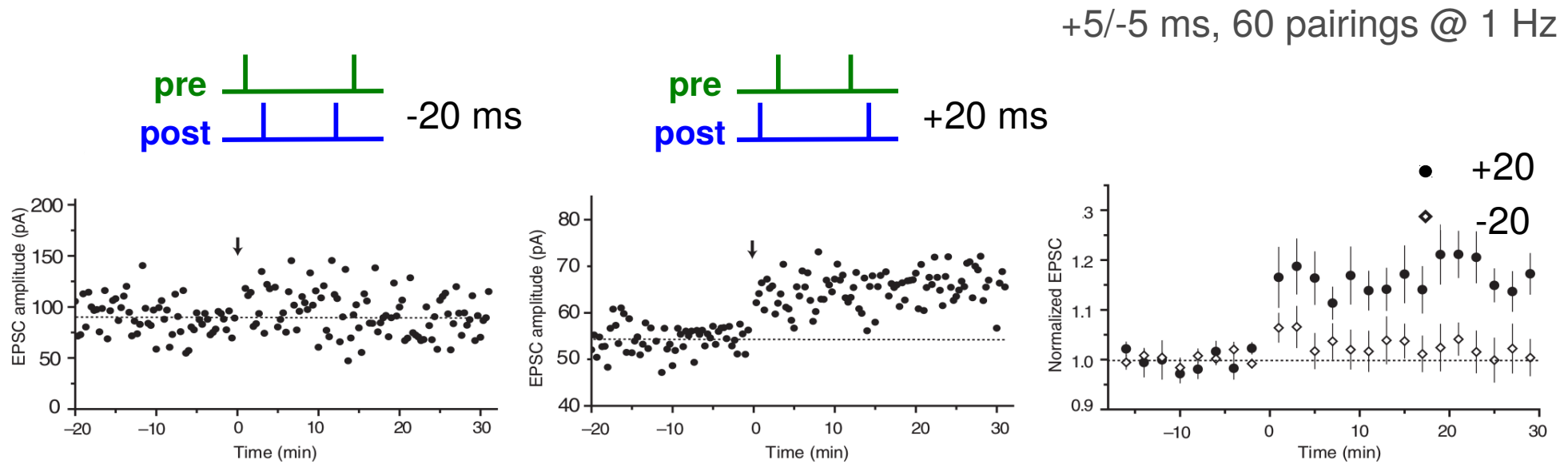

[Wang et al. *Nat Neurosci* 2005]

- Quadruplets : order of pre-post, post-pre pairs determines plasticity outcome

STDP depends on synaptic location

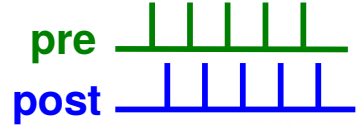

$\Delta t = +10$ ms, 5 pairings, 50 Hz, 15x @ 0.1 Hz

L5 to L5

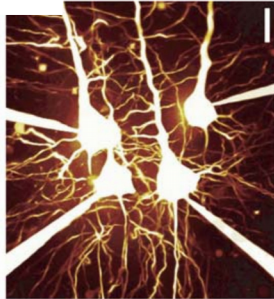

L2/3 to L5

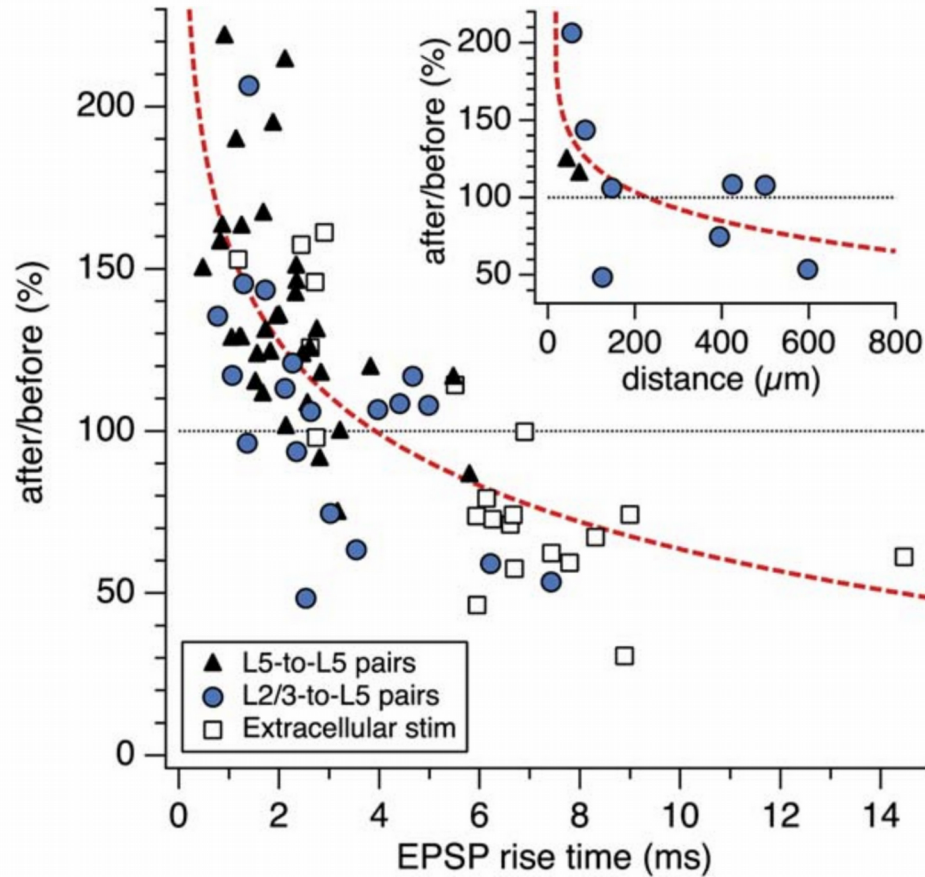
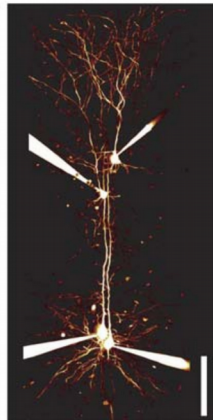

[Sjöström & Hausser, *Neuron* 2006]

[Froemke et al. *Nature*, 2005; Letzkus et al. *J Neurosci* 2006]

- Proximal synapse : LTP
- Distal synapse : LTD

STDP windows depends on brain structure, synapse type

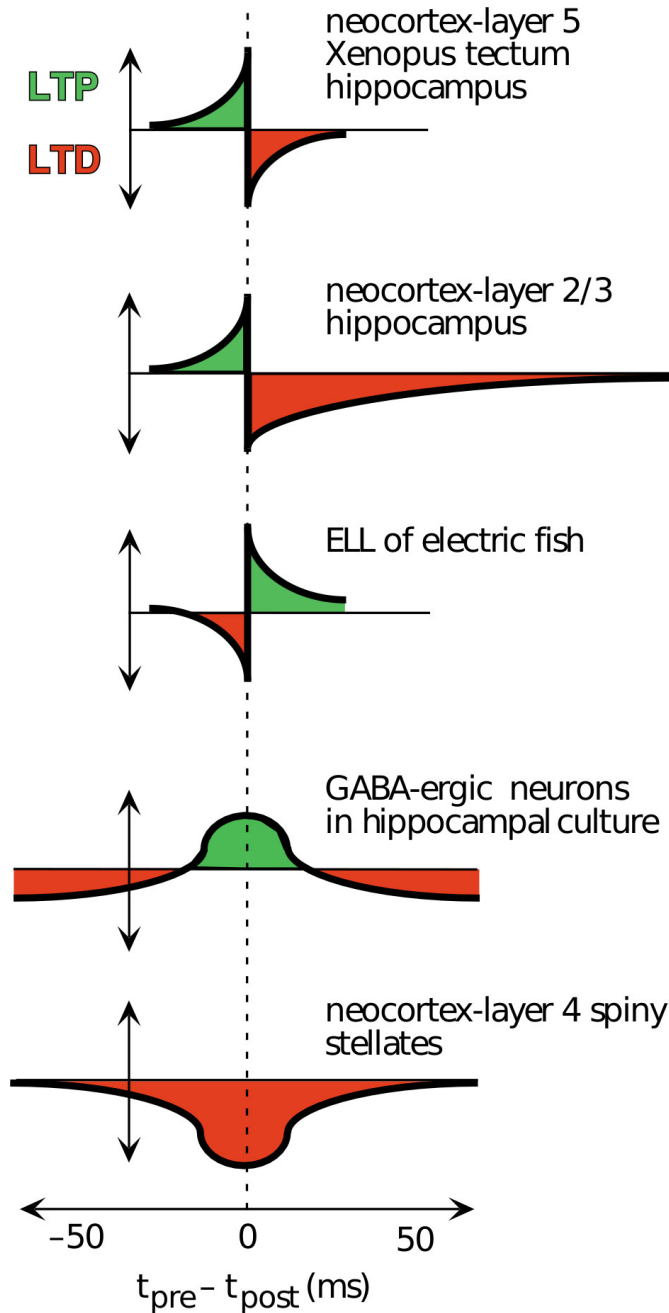

Outline

1. STDP : introduction and history
2. Phenomenology of STDP
- 3. Induction mechanisms**
4. Biophysical models of STDP
5. STDP *in vivo*

Backpropagating action potential required for STDP

stimulated synapse

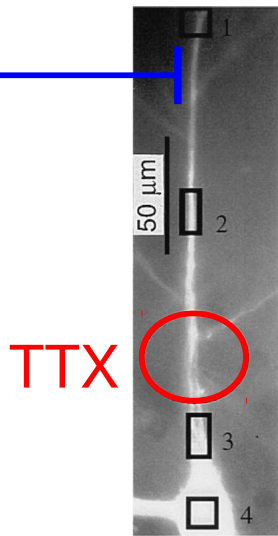

[Ca²⁺] imaging

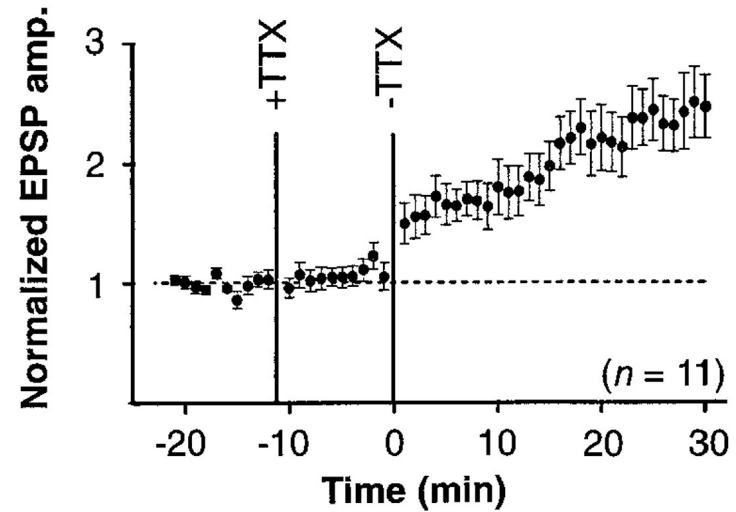
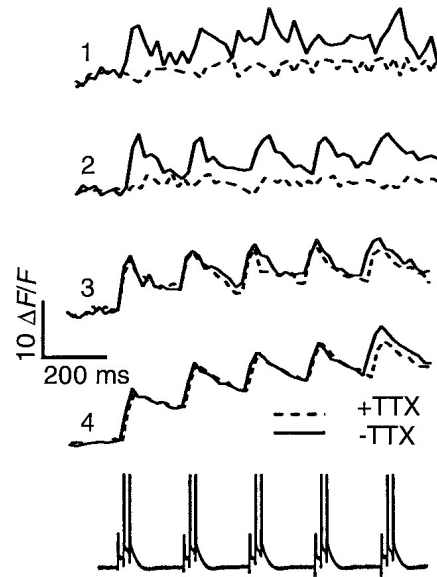

[Magee & Johnston *Science* 1997]

- Backpropagating action potential provides postsynaptic depolarization required for STDP

STDP requires NMDA receptor activation

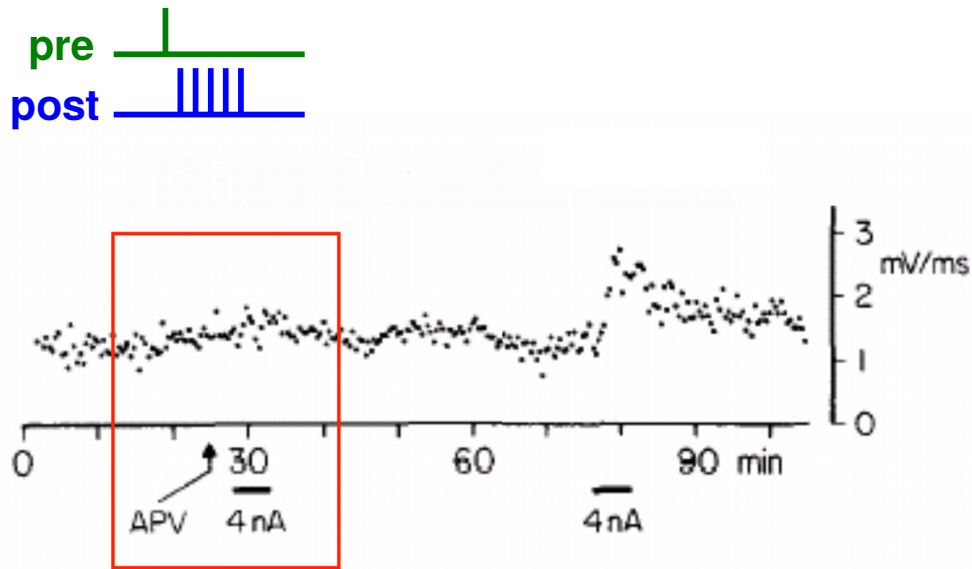

[Gustafsson et al. *J Neurosci* 1987]

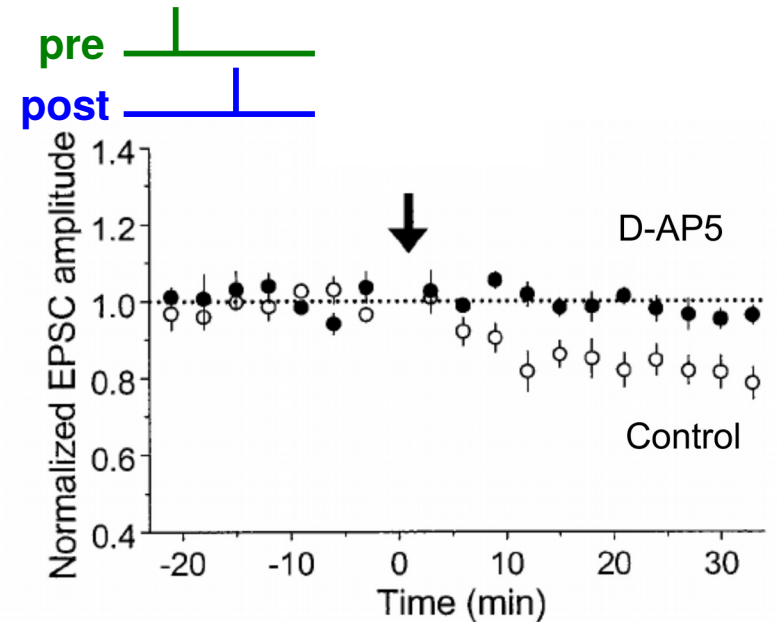

[Bi & Poo *J Neurosci* 1998]

- NMDAR antagonist blocks STDP induction
(D-AP5 or APV is a selective NMDA receptor antagonist)

Postsynaptic NMDA receptor

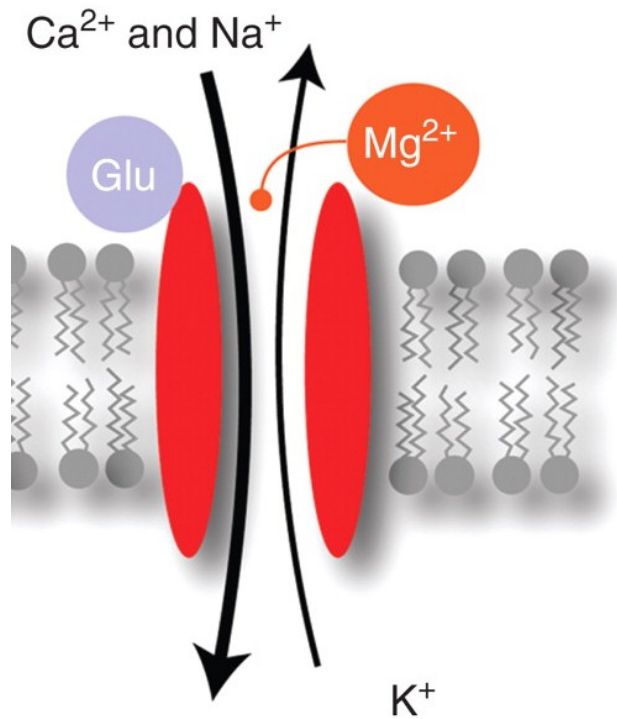

current-voltage relationship

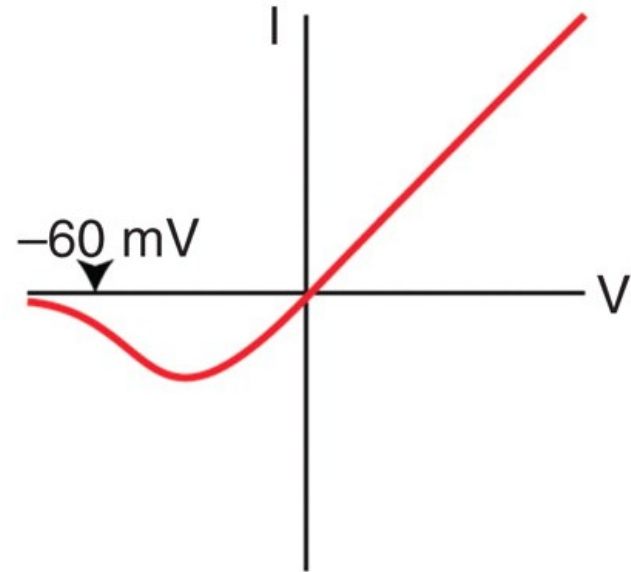

- coincidence detector :
 - presynaptic action potential → glutamate (Glu)
 - postsynaptic depolarization → Mg²⁺ block is expelled
- calcium permeable

Voltage-dependent Ca channels required for LTD

+ nimodipine (L-type calcium channel blocker)

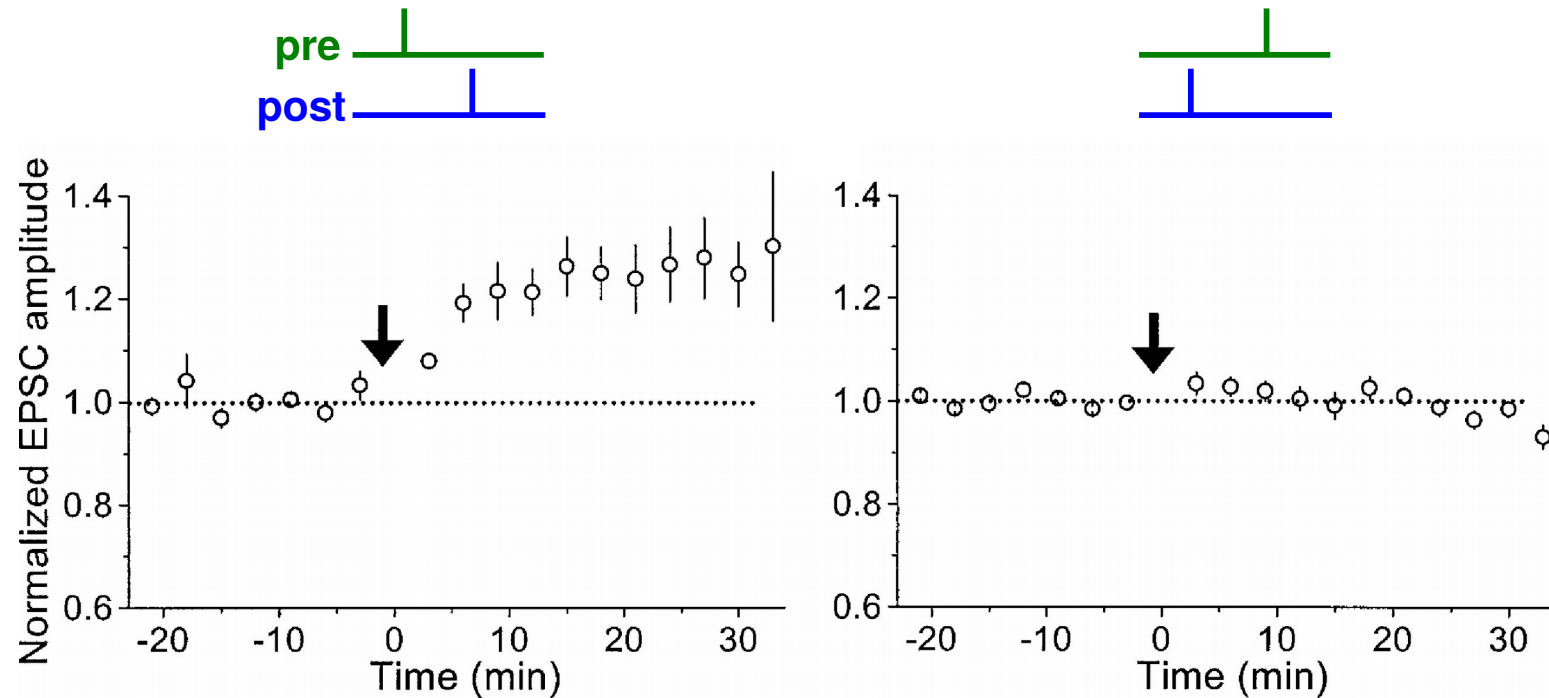

[Bi & Poo *J Neurosci* 1998]

- LTD but not LTP involves the activation of L-type calcium channels

Postsynaptic calcium *required* for plasticity

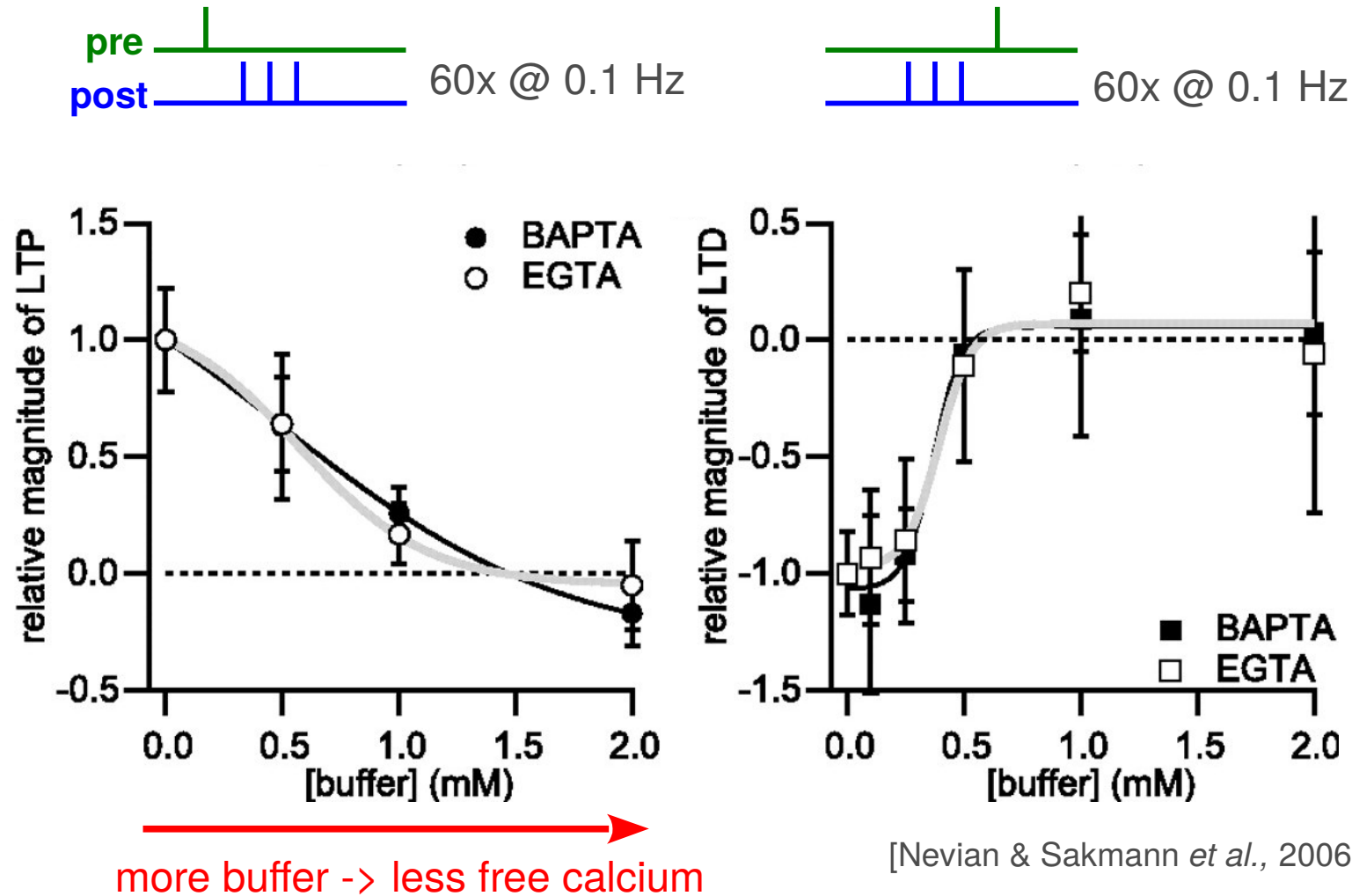

- LTP/LTD equally sensitive to fast and slow $[Ca^{2+}]$ buffers

Postsynaptic calcium *sufficient* for plasticity

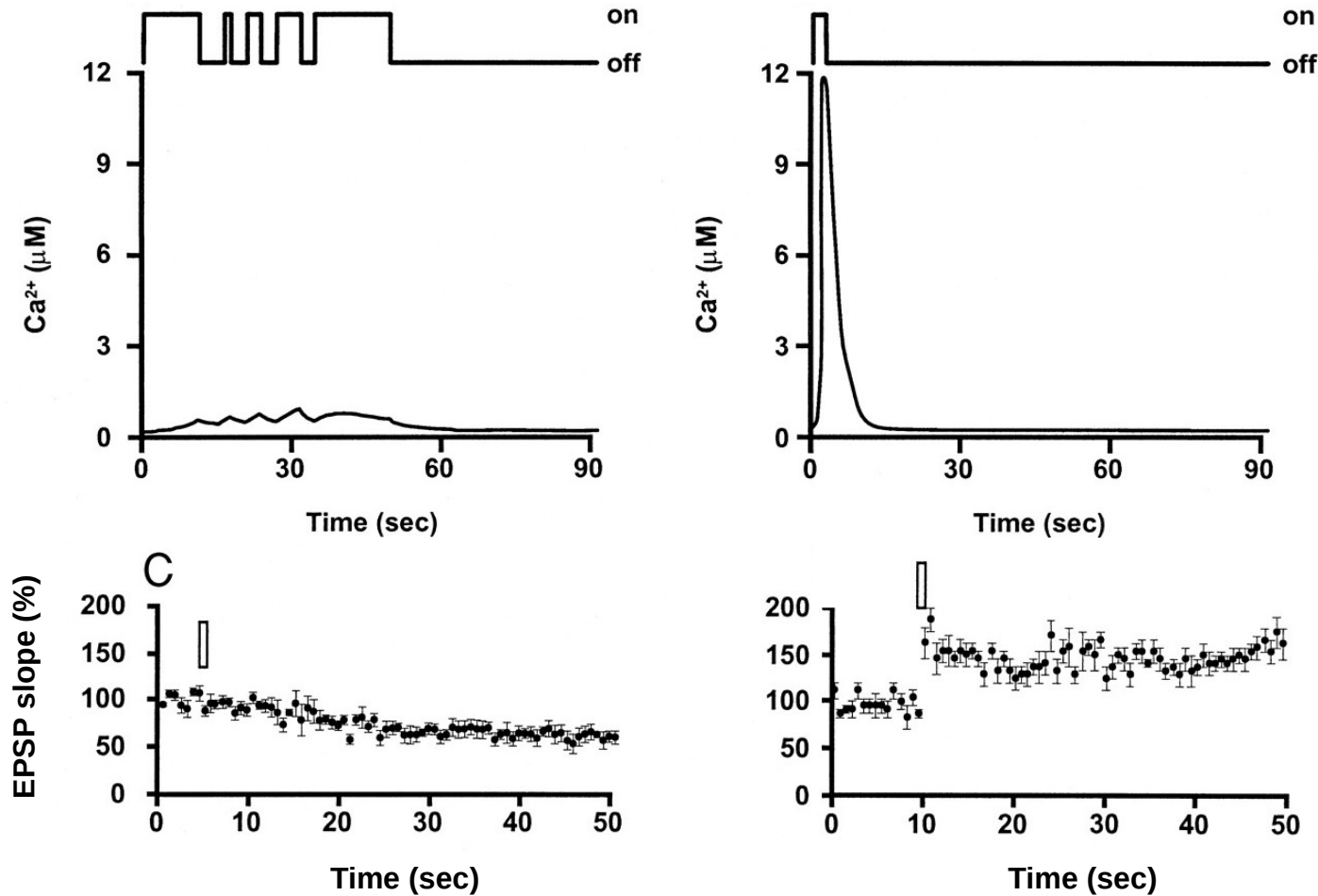

[Malenka *et al. Science* 1988; Yang *et al., J Neurophysiol* 1999]

- LTP induced by brief, large amplitude [Ca²⁺] increases
- prolonged, modest rise in [Ca²⁺] elicits LTD

NMDA receptor activation but no calcium required for LTD

[Nabavi *et al.*, 2013, PNAS]

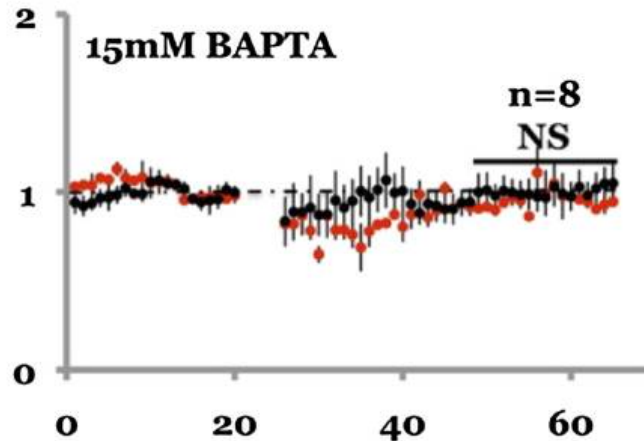

complete block of calcium

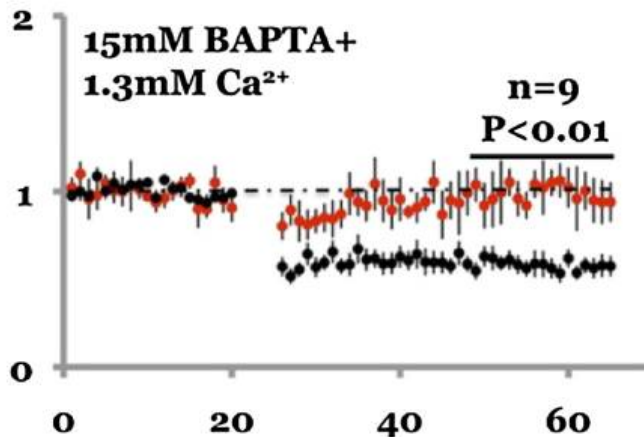

maintaining resting calcium levels

- ligand binding to NMDA receptors is sufficient for LTD
- basal levels of [Ca²⁺] are permissively required

Signal pathways downstream of Calcium

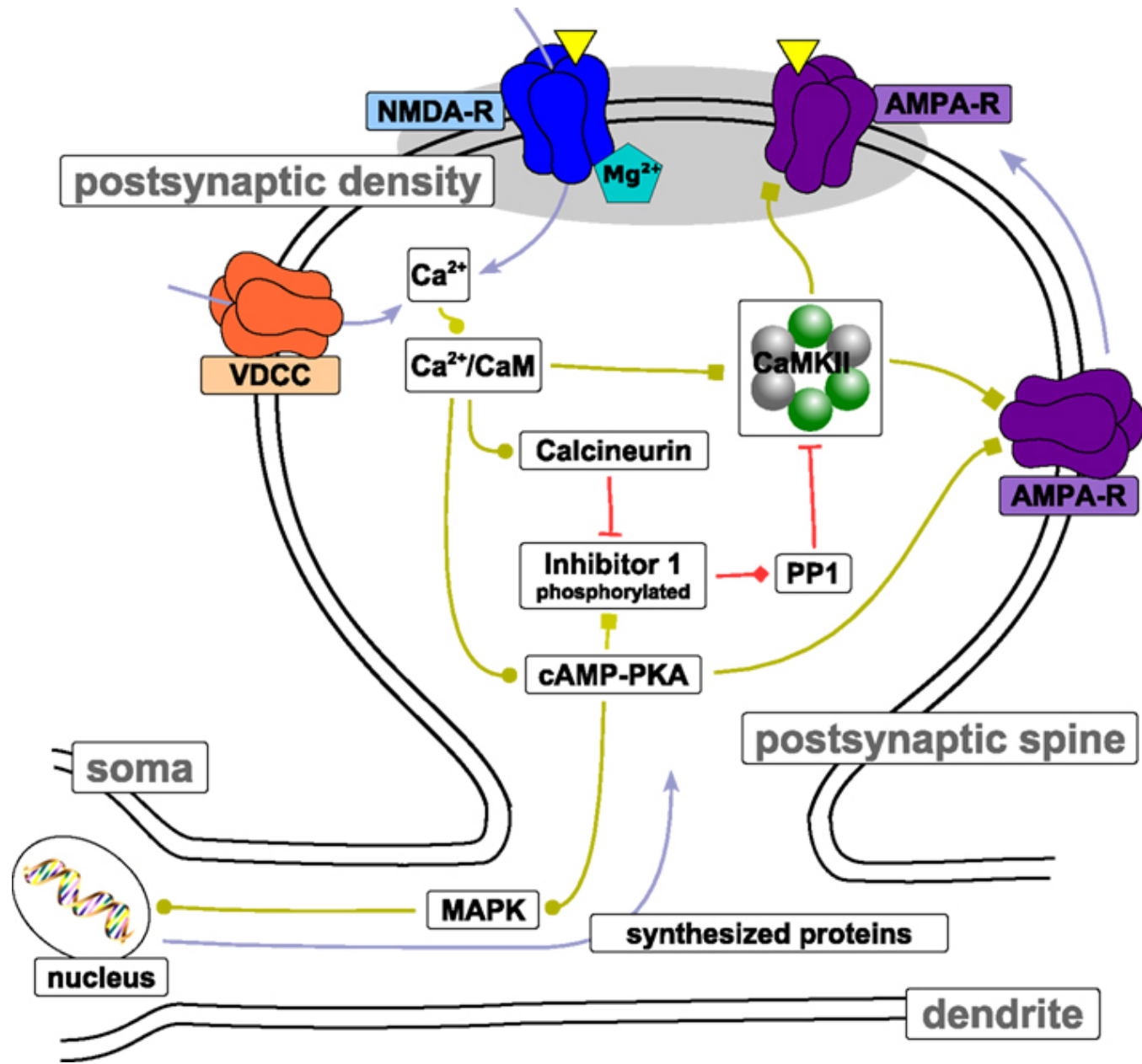

3. Induction mechanisms

Diversity of induction and expression pathways

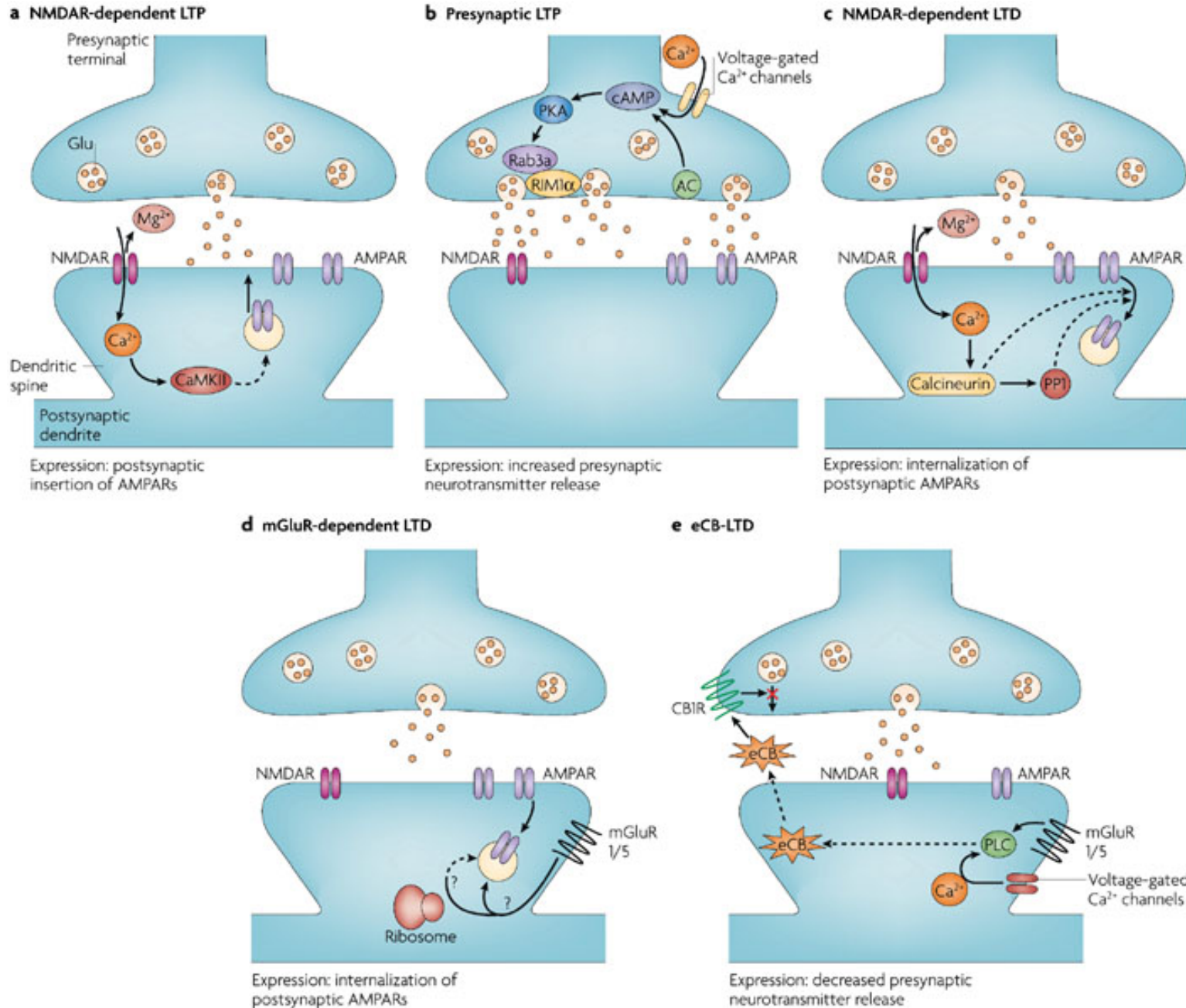

[Kauer, Malenka. *Nat Rev Neurosci* 2010]

Expression of long-term changes

presynaptic

postsynaptic

neurotransmitter vesicle
number

number of AMPA receptors

probability of vesicle
release

conductance of AMPA
receptors

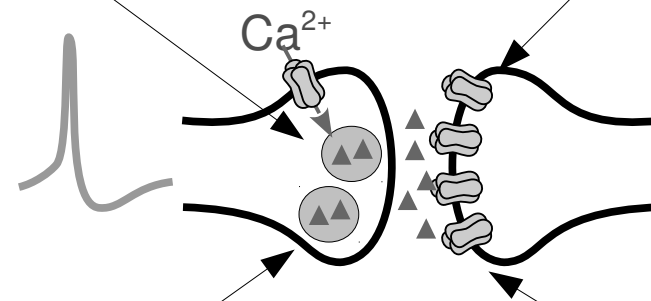

Outline

1. STDP : introduction and history
2. Phenomenology of STDP
3. Induction mechanisms
- 4. Biophysical models of STDP**
5. STDP *in vivo*

Modeling : translation from spikes to plasticity results

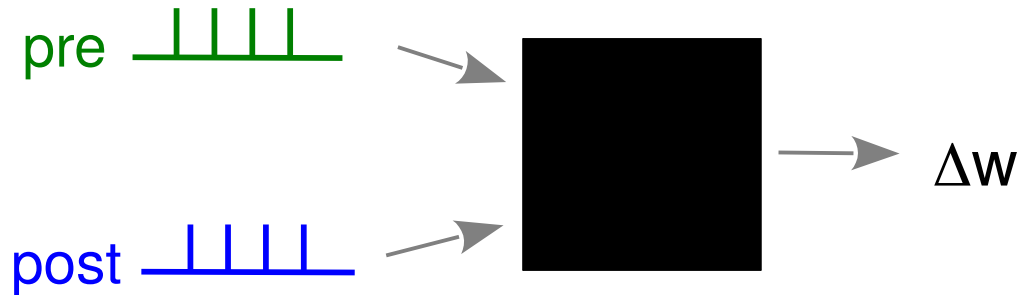
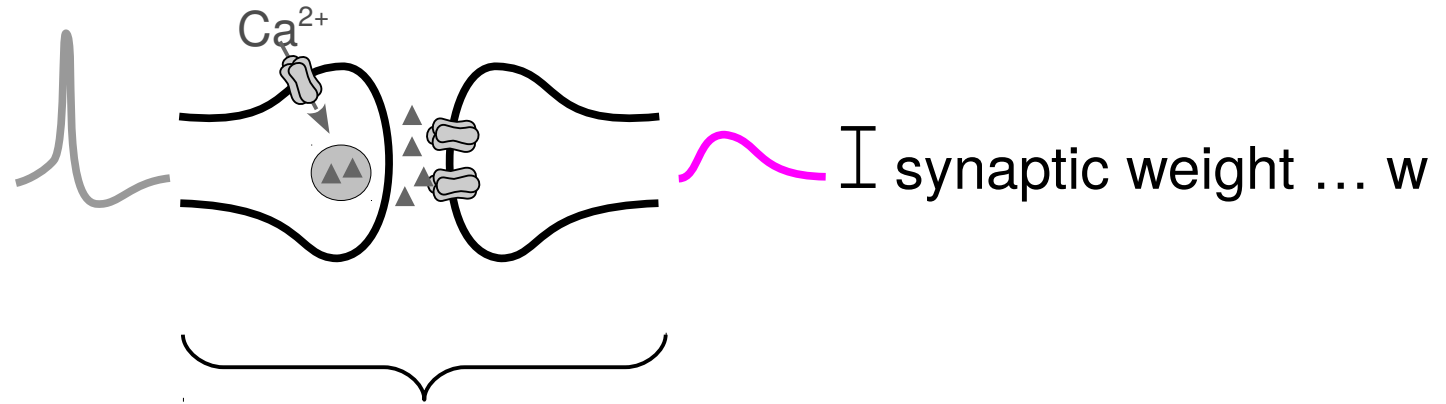

“Standard” STDP model

- spike-timing based rules : $\Delta w_{ij} = f(\{t_{ik}\}, \{t_{jk}\})$

- “standard” STDP :

$$f(\{t_{ik}\}, \{t_{jk}\}) = \sum_{k, k'} F(t_{ik} - t_{jk'})$$

$$F(\Delta t) = \begin{cases} A_+ \exp(-\Delta t / \tau_+) & \Delta t > 0 \\ A_- \exp(-\Delta t / \tau_-) & \Delta t < 0 \end{cases}$$

- Variations of the rule :
 - * additive/multiplicative
 - * All-to-all spike pairings / nearest neighbors
- **Problems** : does not depend on firing rate
does not resolve the nonlinearities of plasticity

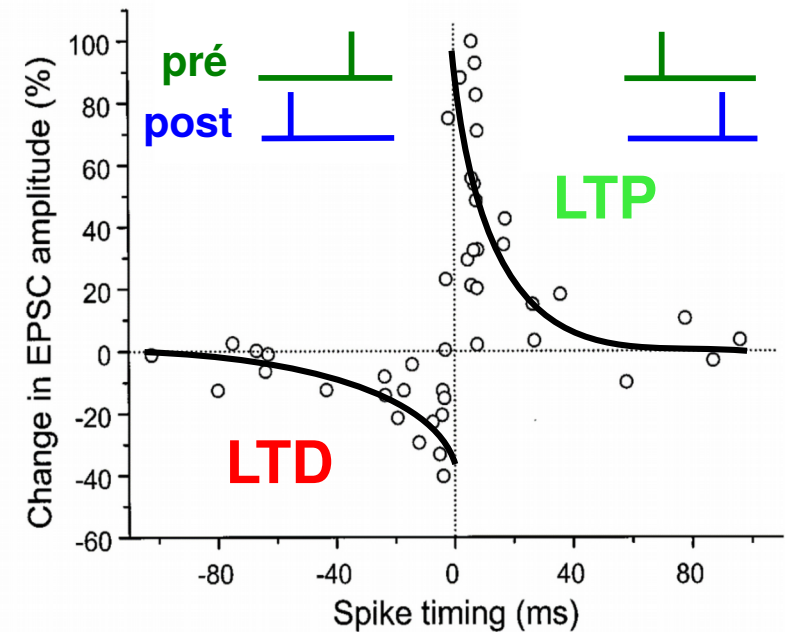

More recent plasticity models

Triplet-based model

[Pfister & Gerstner, 2006;
Clopath et al., 2010]



Model based on postsynaptic potential

[Clopath et al., 2010]

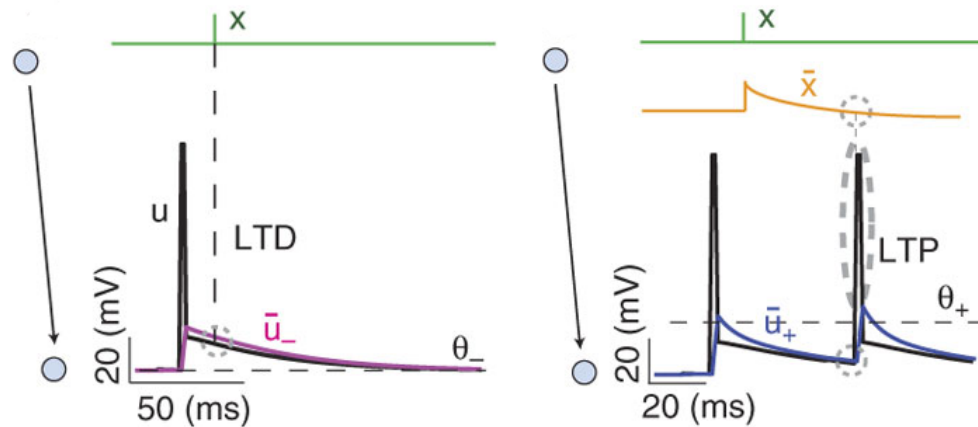

Calcium-based model

[Shouval et al. 2002, Graupner & Brunel 2012]

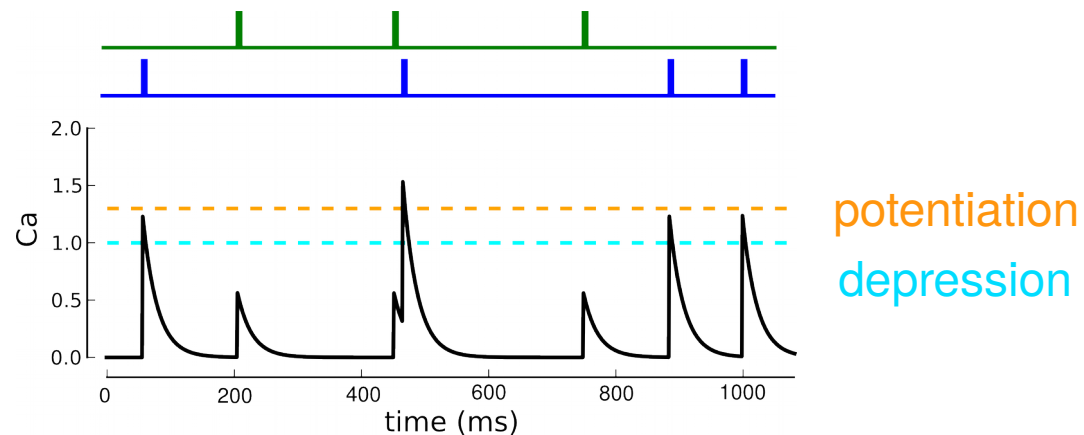

Modeling approaches : phenomenological vs. biophysical

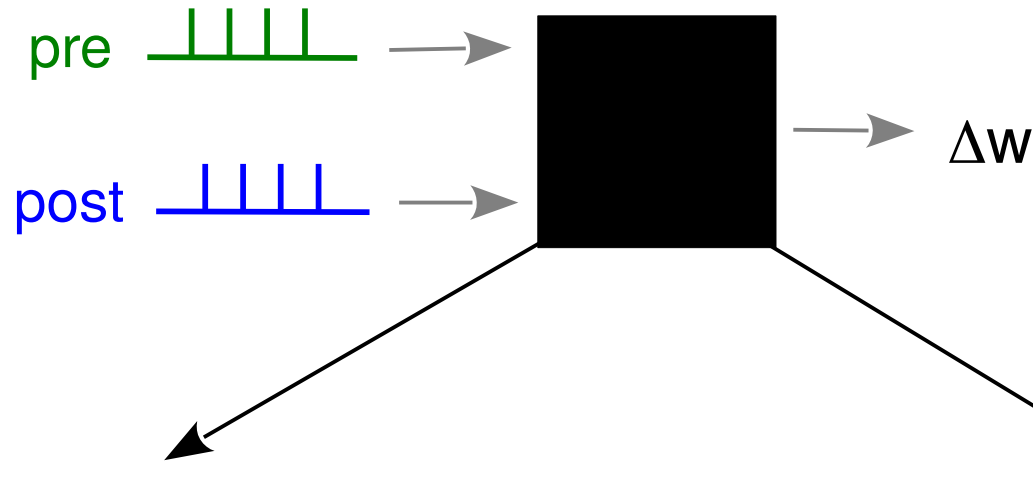

phenomenological models of
LTP/LTD

- use pre- and postsynaptic spike times or rate to calculate change in synaptic strength
- conversion can involve arbitrarily complex mathematical models

biophysical models of
LTP/LTD

- resolve *parts* of the underlying biological machinery involved in the induction of plasticity
- degree of biological detail varies largely

Modeling studies : phenomenological vs. biophysical

phenomenological models of LTP/LTD

- **rate-based plasticity models**
[Hebb, 1949; Bienenstock *et al.*, 1982;
Oja, 1982]
- **spike-timing based models**
[Gerstner *et al.*, 1996; van Rossum *et al.* 2000;
Song, 2000; Pfister & Gerstner, 2006]

biophysical models of LTP/LTD

- **Ca²⁺ – dynamics based models**
[Karmarkar *et al.*, 2002; Shouval *et al.*, 2002;
Rubin *et al.*, 2005; Graupner & Brunel 2012]
- **CaMKII kinase-phosphatase system**
[Crick 1984; Lisman, 1985;
Okamoto & Ichikawa, 2000; Zhabotinsky, 2000;
Graupner & Brunel, 2007; Urakubo *et al.*, 2008]
- **extensive protein networks**
[Bhalla & Iyengar, 1999; Hayer & Bhalla, 2005]
- **local clustering of receptors**
[Shouval, 2005]

Modeling studies : phenomenological vs. biophysical

phenomenological models of LTP/LTD

- **rate-based plasticity models**
[Hebb, 1949; Bienenstock *et al.*, 1982;
Oja, 1982]
- **spike-timing based models**
[Gerstner *et al.*, 1996; van Rossum *et al.* 2000;
Song, 2000; Pfister & Gerstner, 2006]

biophysical models of LTP/LTD

- **Ca²⁺ – dynamics based models**
[Karmarkar *et al.*, 2002; Shouval *et al.*, 2002;
Rubin *et al.*, 2005; Graupner & Brunel 2012]
- **CaMKII kinase-phosphatase system**
[Crick 1984; Lisman, 1985;
Okamoto & Ichikawa, 2000; Zhabotinsky, 2000;
Graupner & Brunel, 2007; Urakubo *et al.*, 2008]
- **extensive protein networks**
[Bhalla & Iyengar, 1999; Hayer & Bhalla, 2005]
- **local clustering of receptors**
[Shouval, 2005]

Calcium influx

coincidence detector :

glutamate
presynaptic
activity

+

depolarization
pre- or postsynaptic
activity

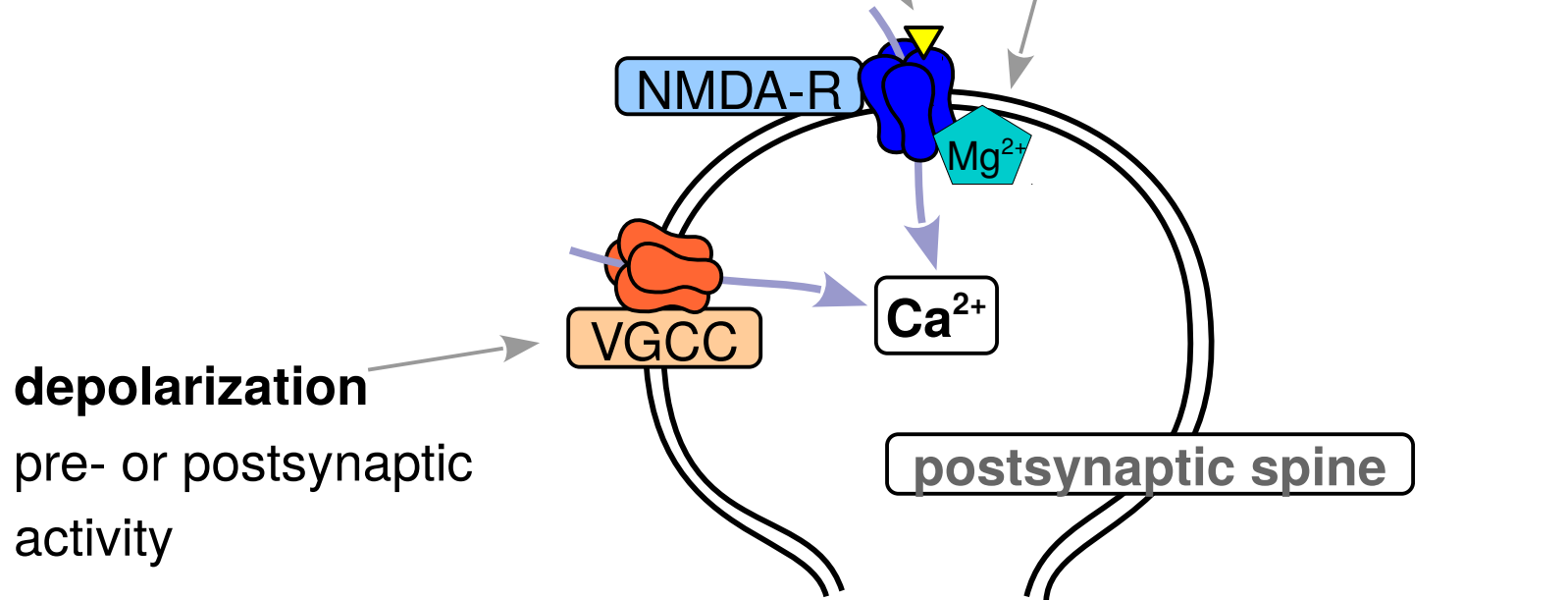

Calcium transients from spike-pair stimulation

[simulation]

Calcium control hypothesis

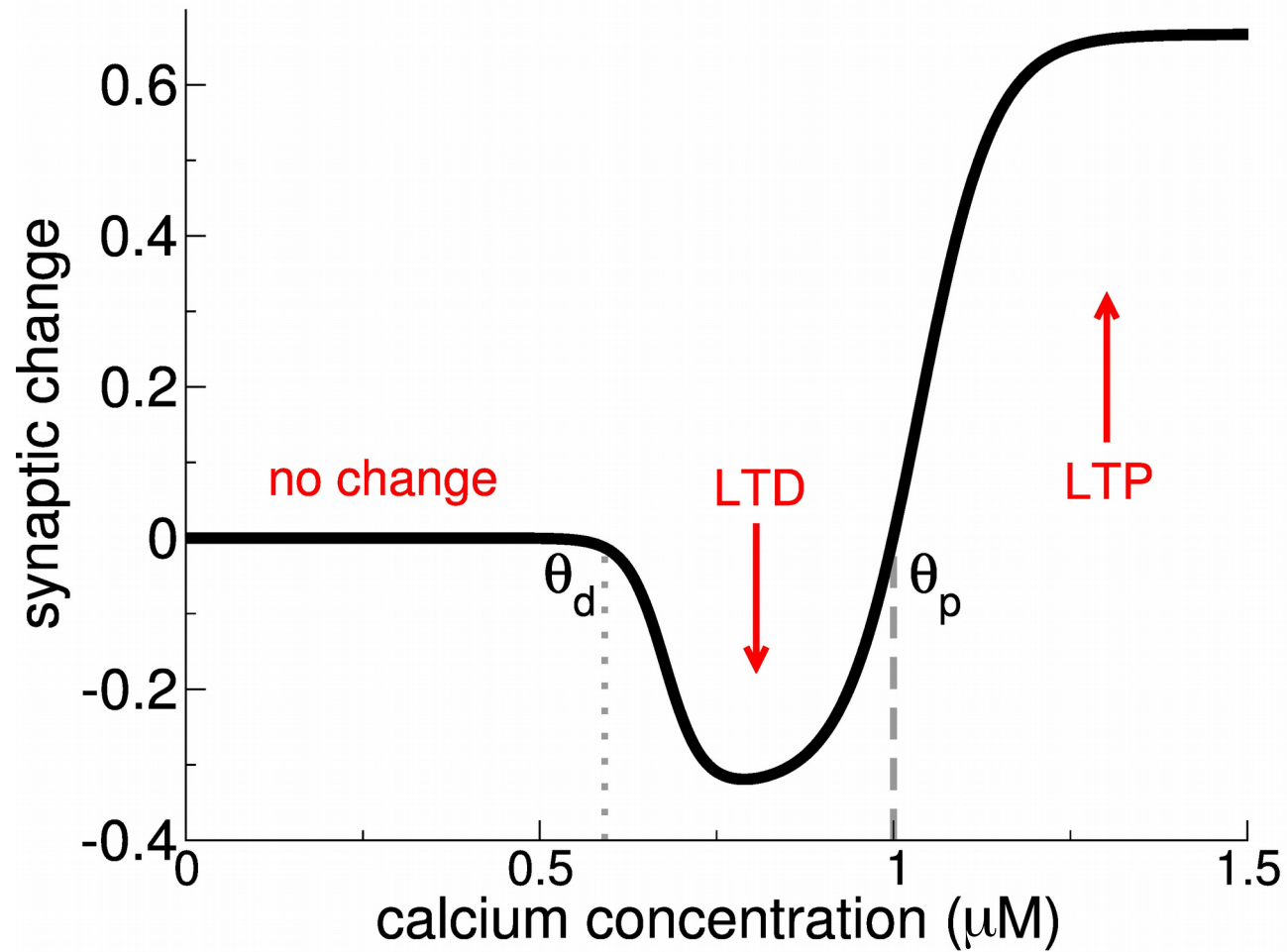

[Shouval *et al.*, *PNAS* 2002]

Calcium transients from spike-pair stimulation

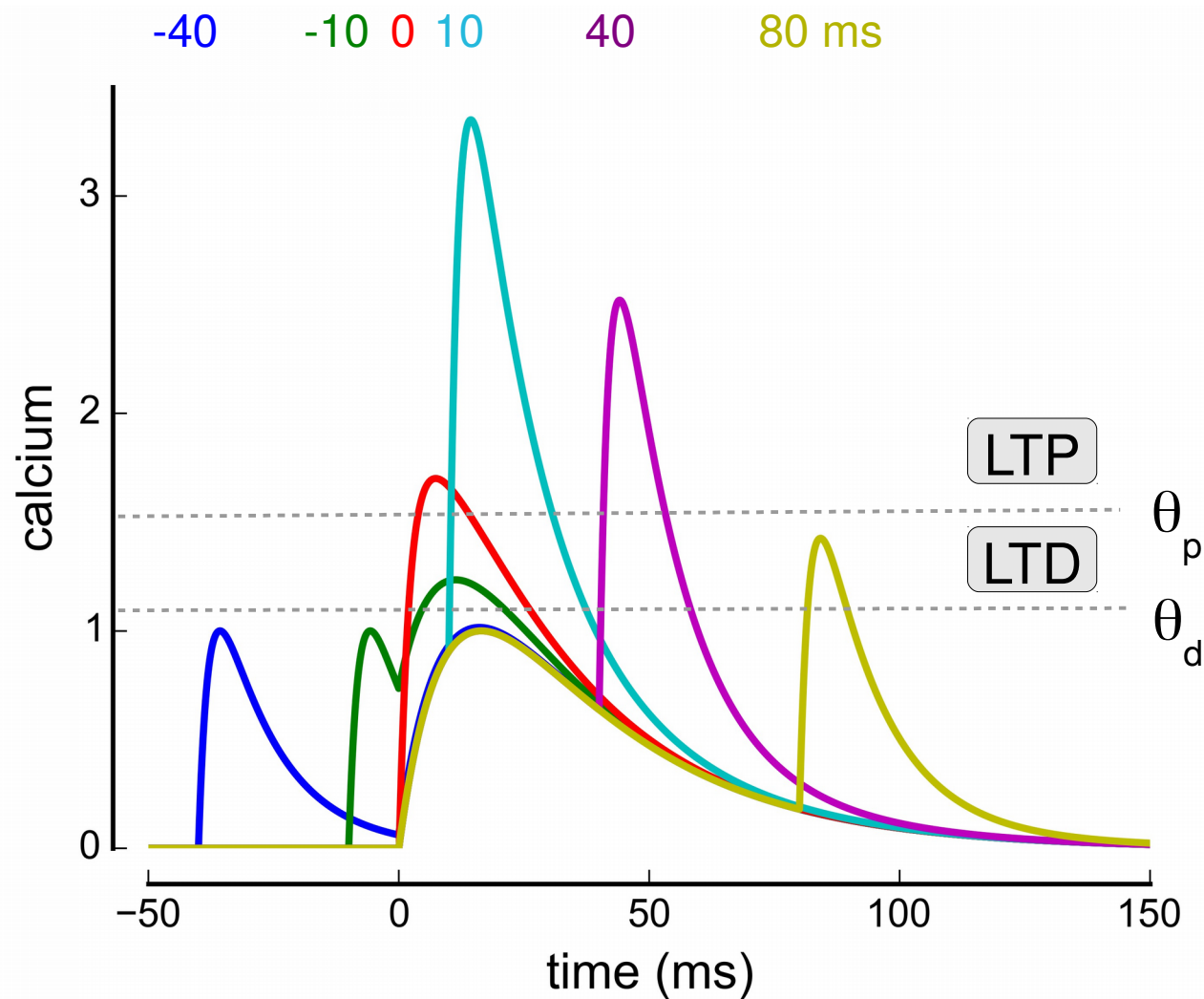

STDP curve from calcium control hypothesis

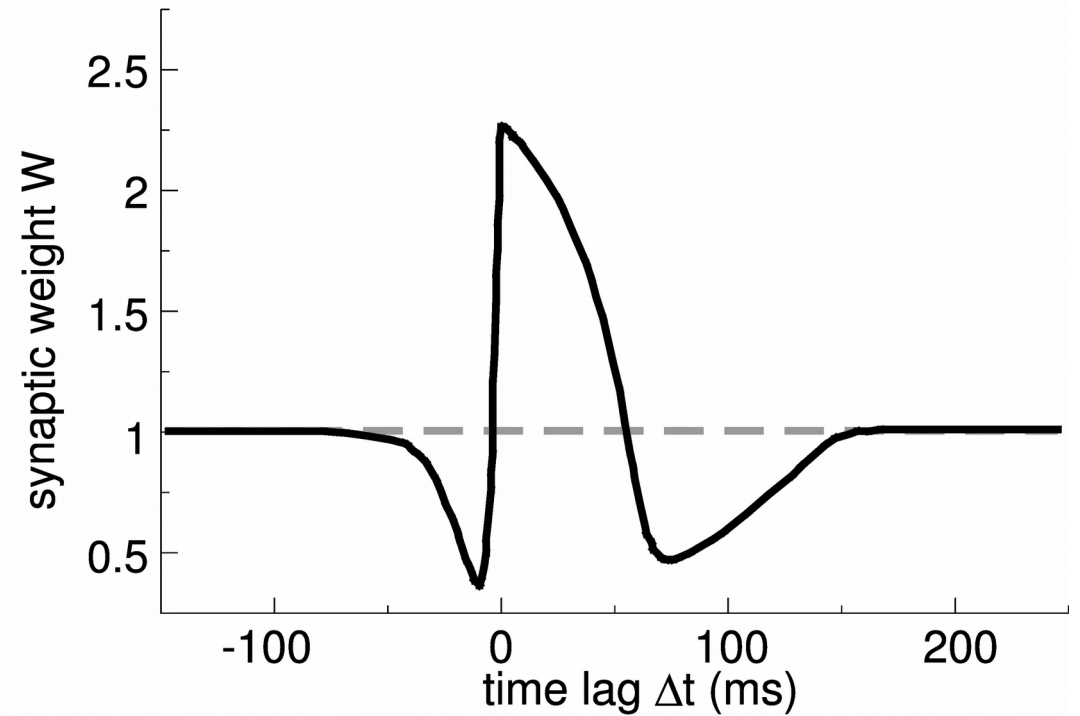
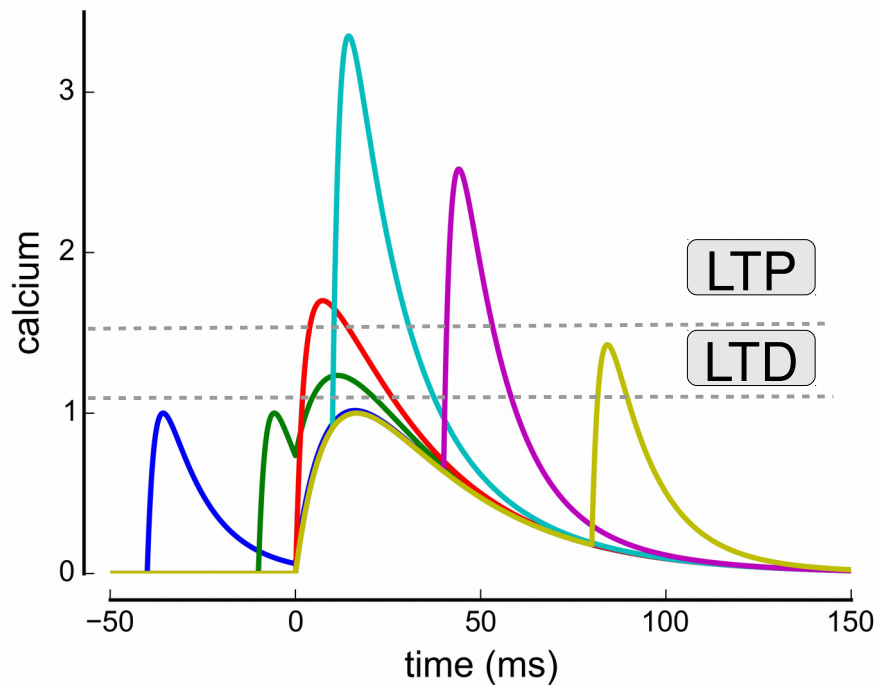

STDP curve from calcium control hypothesis

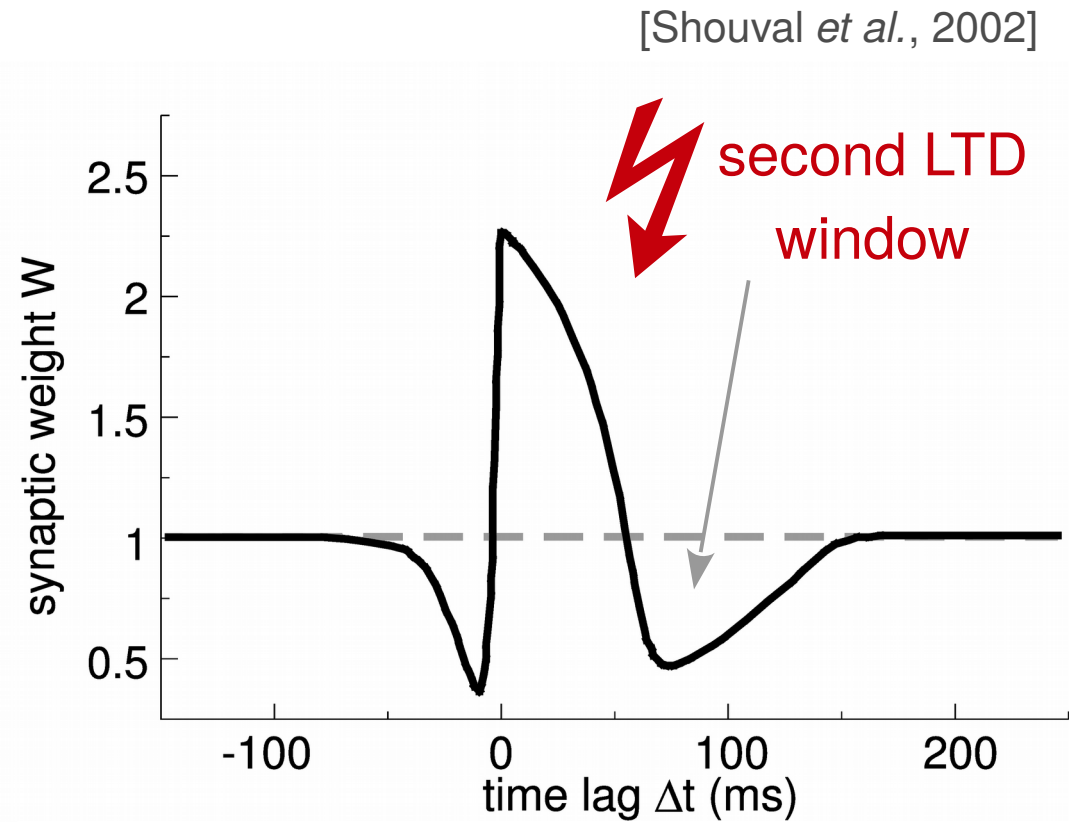
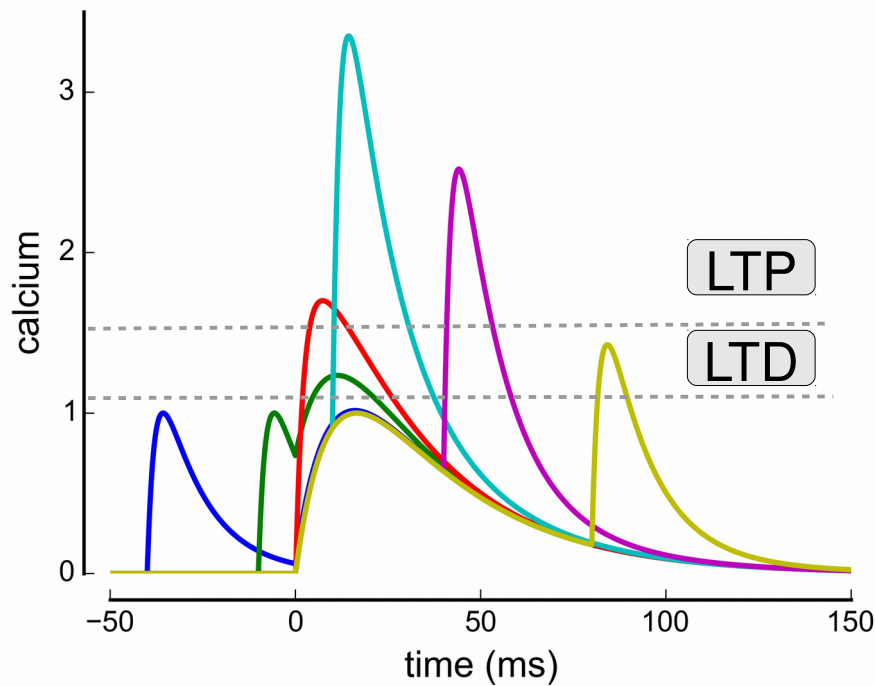

→ [Karmarkar *et al.*, 2002; Badoual *et al.*, 2006; Rubin *et al.*, 2005; Urakubo *et al.*, 2008; Graupner & Brunel 2012 ...]

Question : role of calcium in shaping STDP

- I. Can the dynamics of the postsynaptic calcium account for synaptic plasticity induced by spike-pairs ?
- II. How much of the STDP phenomenology can be explained by calcium ?

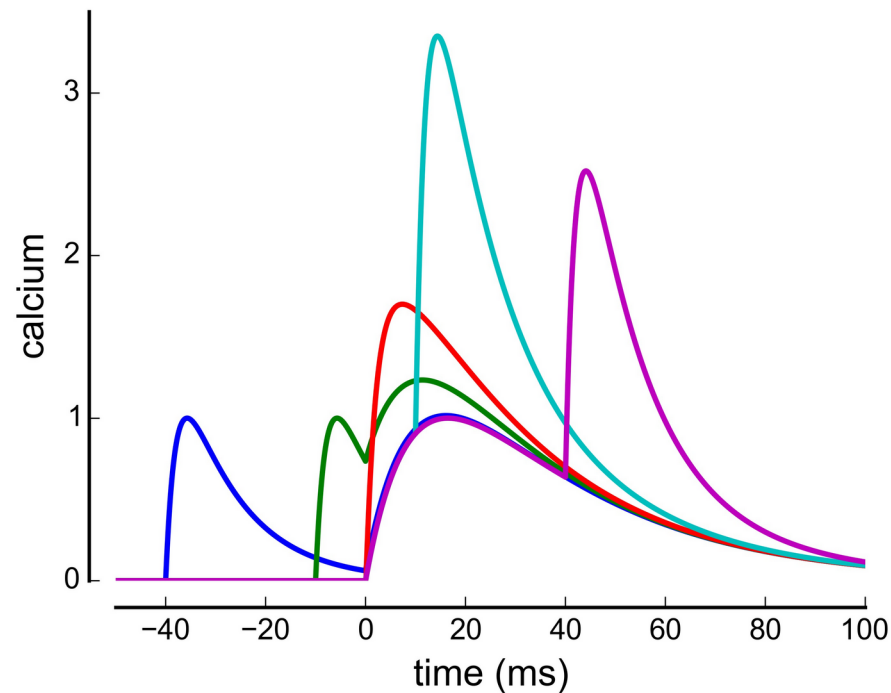

Calcium amplitudes determine shape of STDP curve

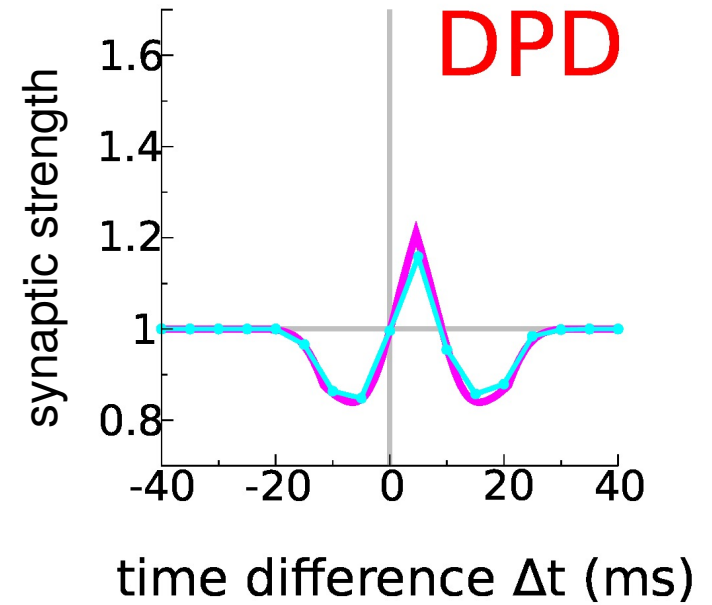
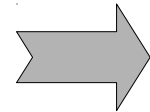
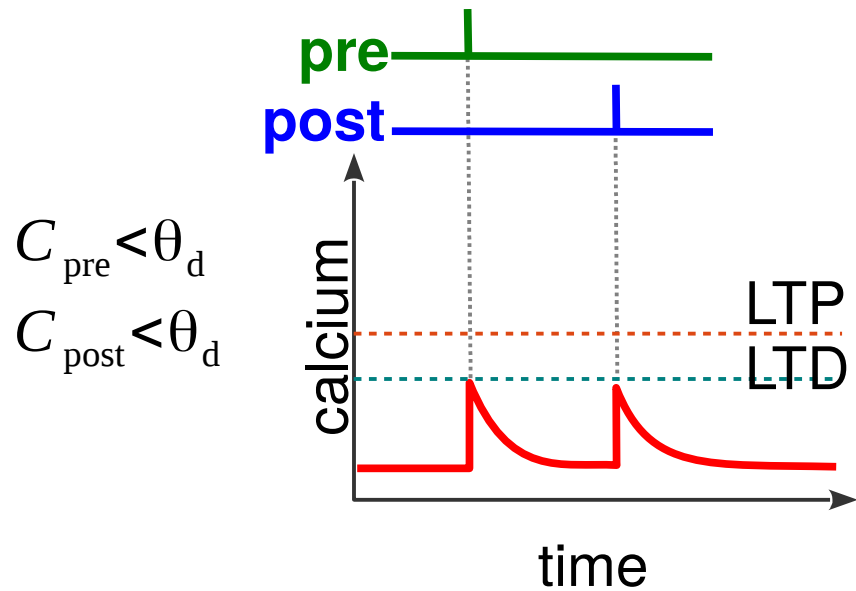

Calcium amplitudes determine shape of STDP curve

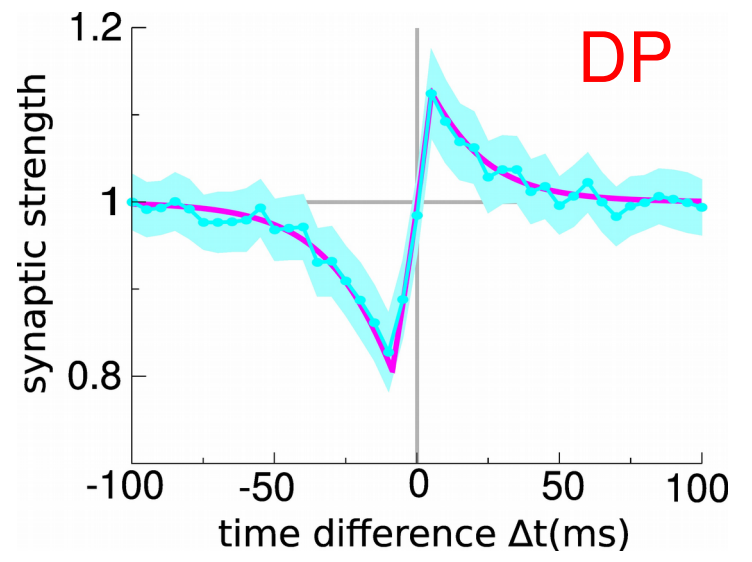
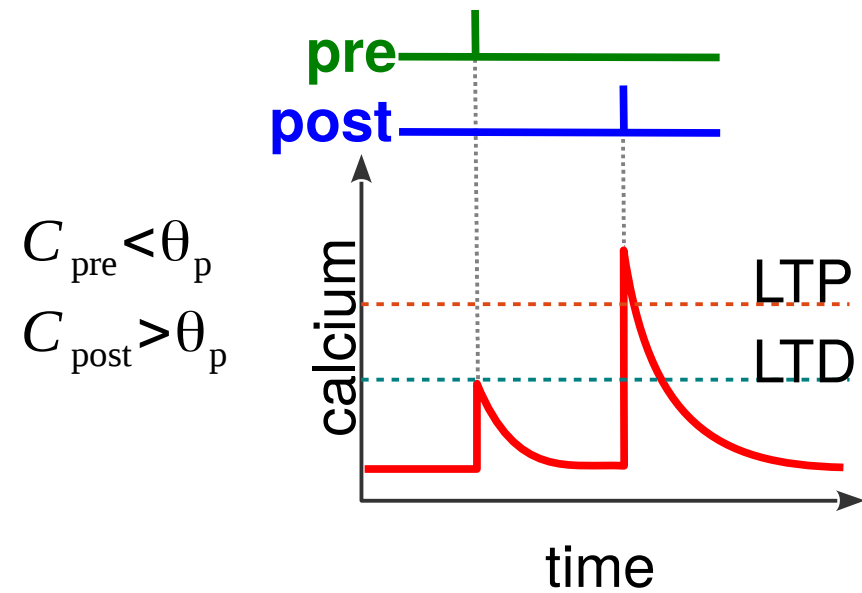
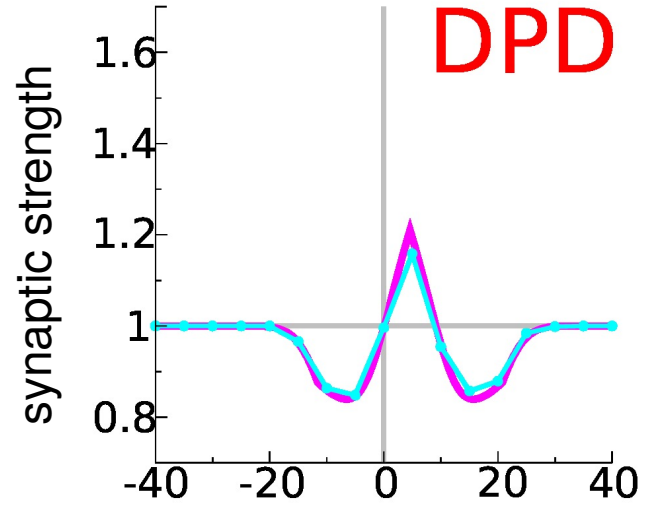
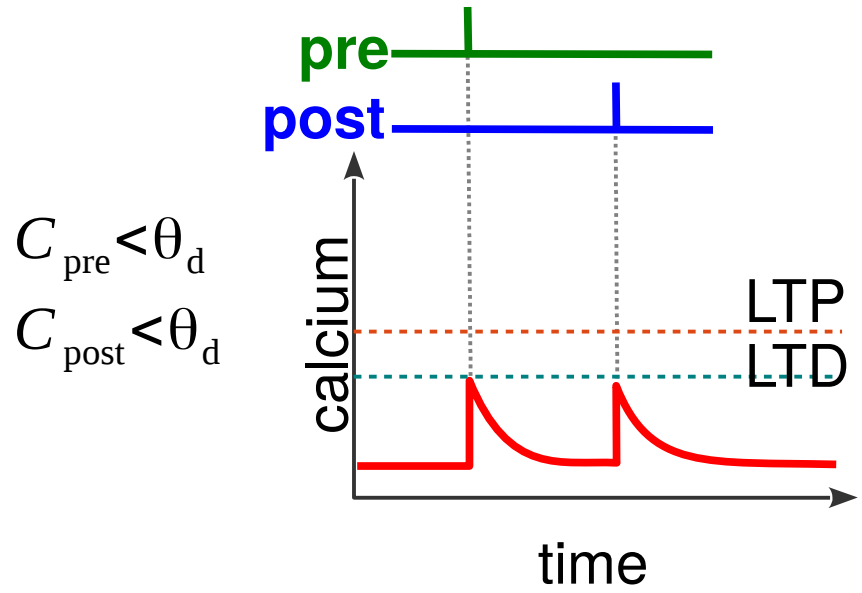

Calcium amplitudes determine shape of STDP curve

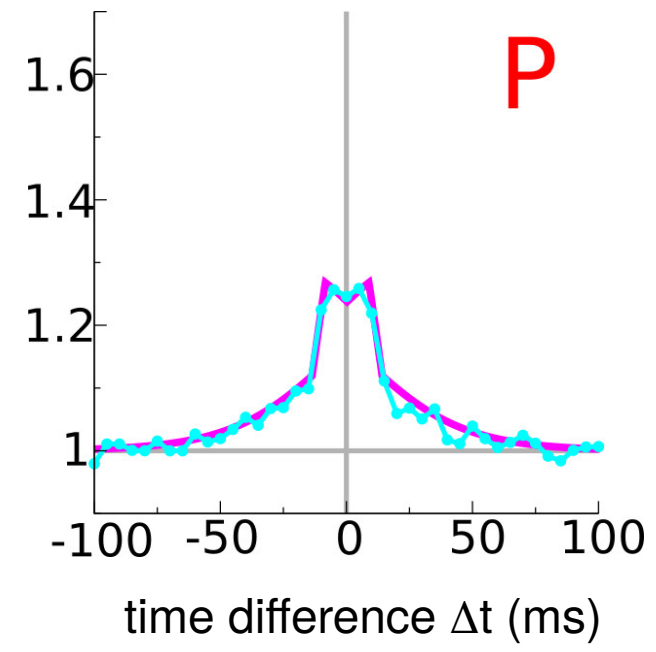
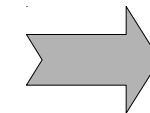
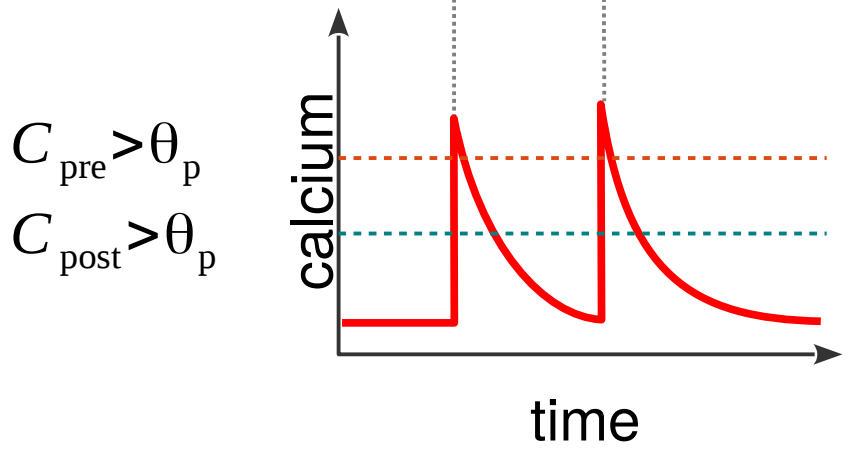
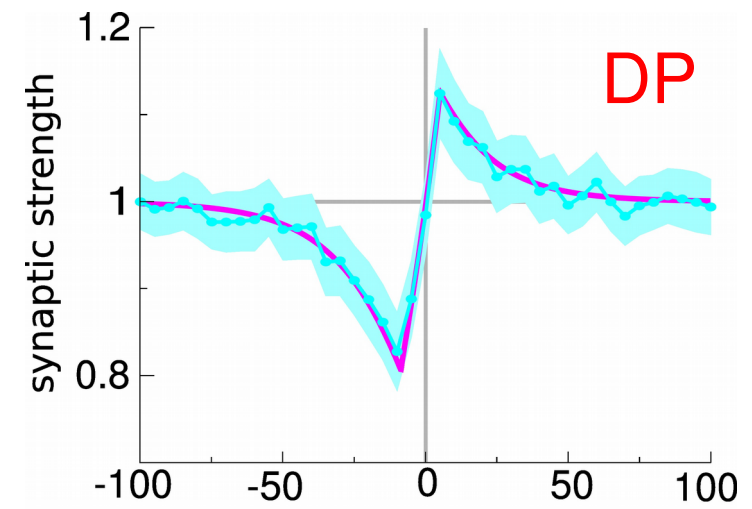
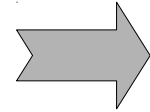
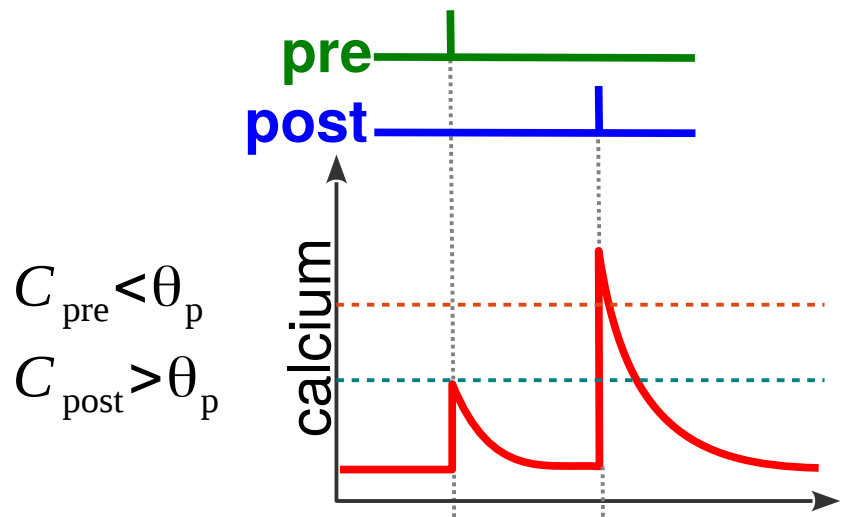

Calcium amplitudes determine shape of STDP curve

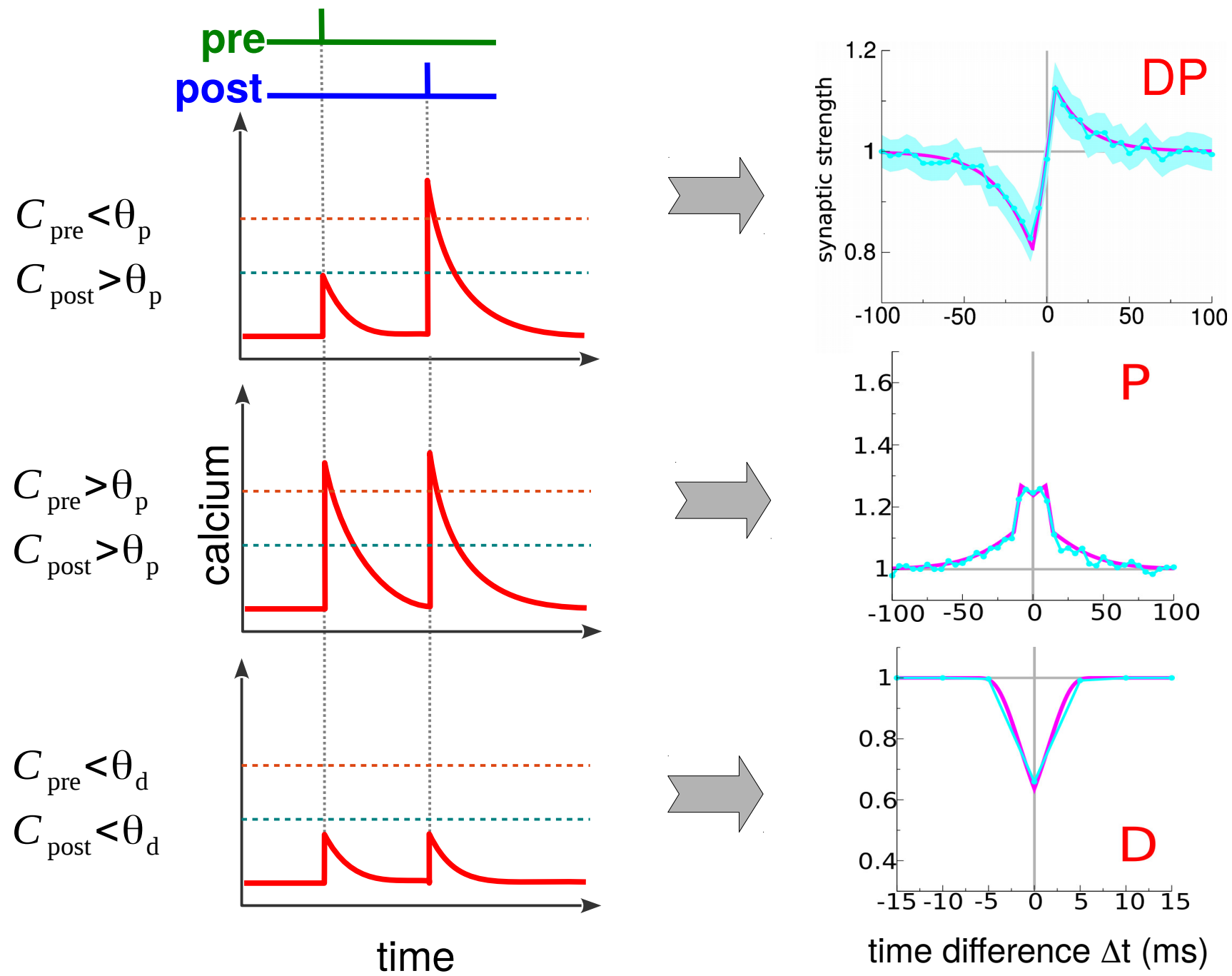

Diversity of STDP curves : spike-pair stimulation

D ... depression , P ... potentiation

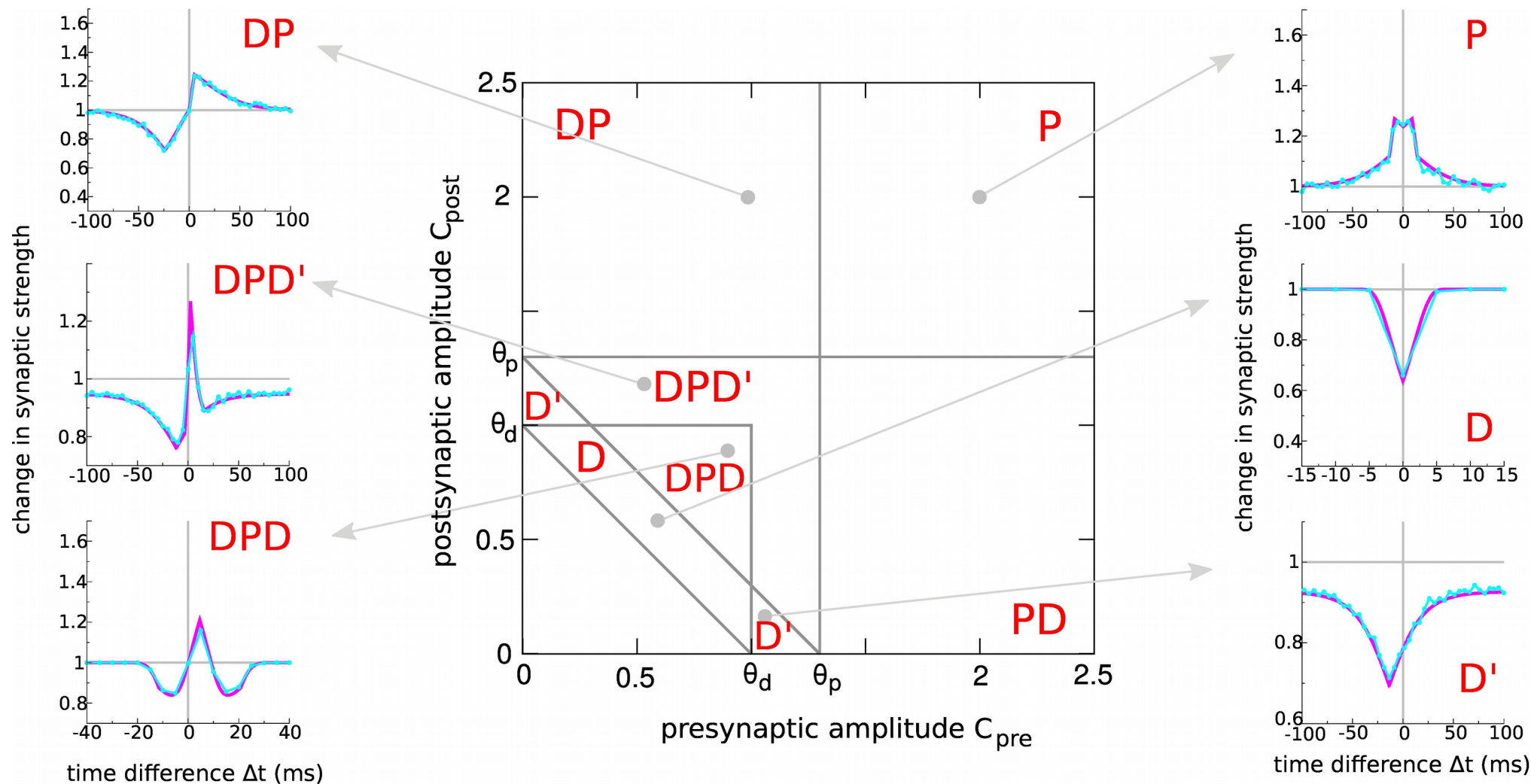

Diversity of STDP curves : experimental results

- neocortex-layer V
- hippocampus
- Xenopus tectum

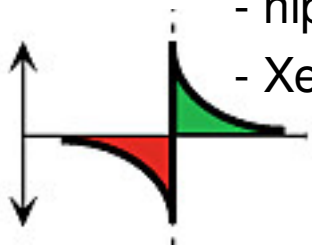

- ELL of electric fish
- corticostriatal synapse

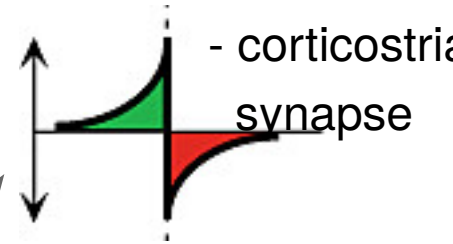

- GABA-ergic neurons in hippocampal cultures

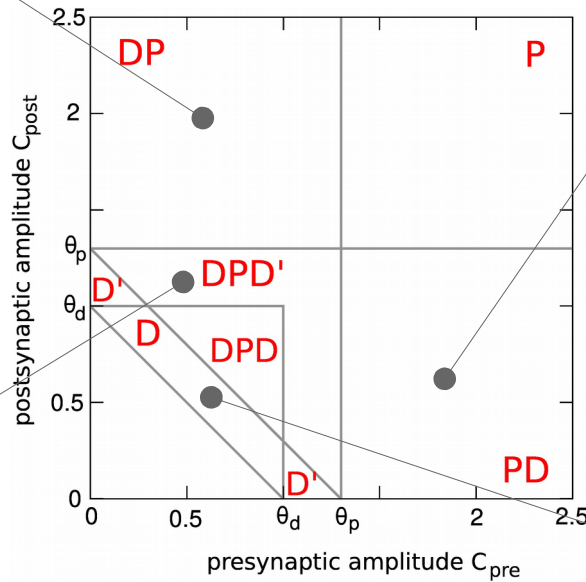

- neocortex-layer IV spiny stellates
- hippocampus

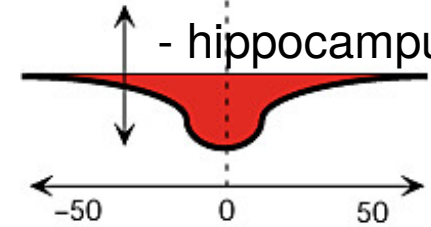

Outline

1. STDP : introduction and history
2. Phenomenology of STDP
3. Induction mechanisms
4. Biophysical models of STDP
5. STDP *in vivo* ?

Firing patterns : Realistic firing is highly irregular

- stimulation protocols used to induce plasticity

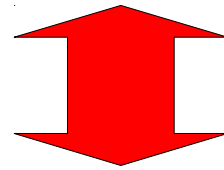
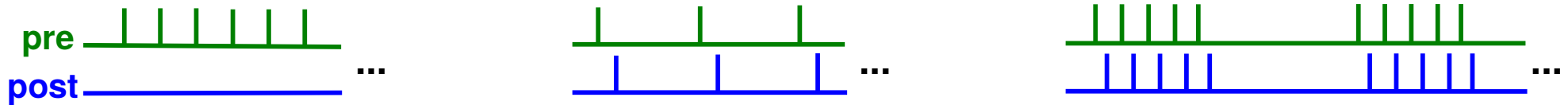

- *in vivo* firing patterns

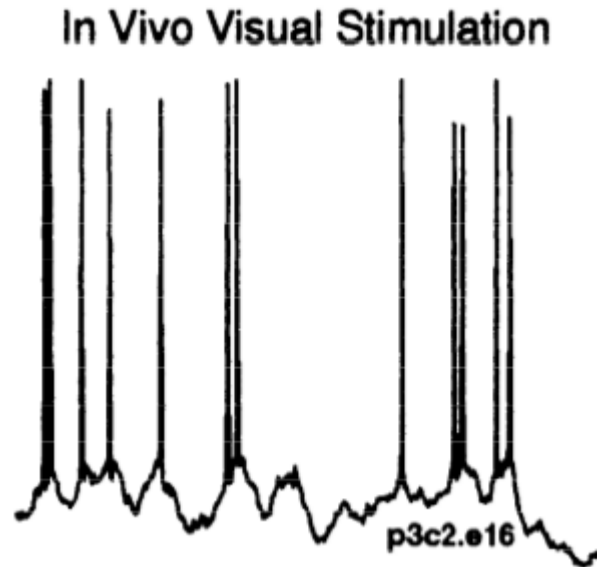

[Holt *et al.*, 1996]

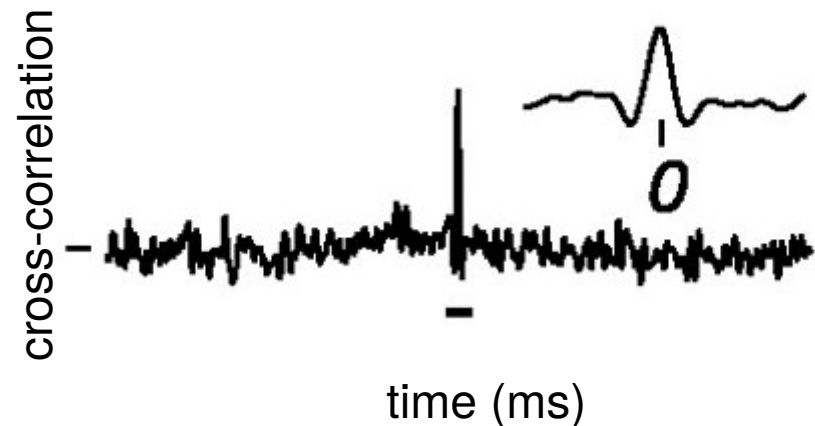

[Kohn and Smith, 2005]

Regular vs. irregular spike-pairs

regular spike-pairs

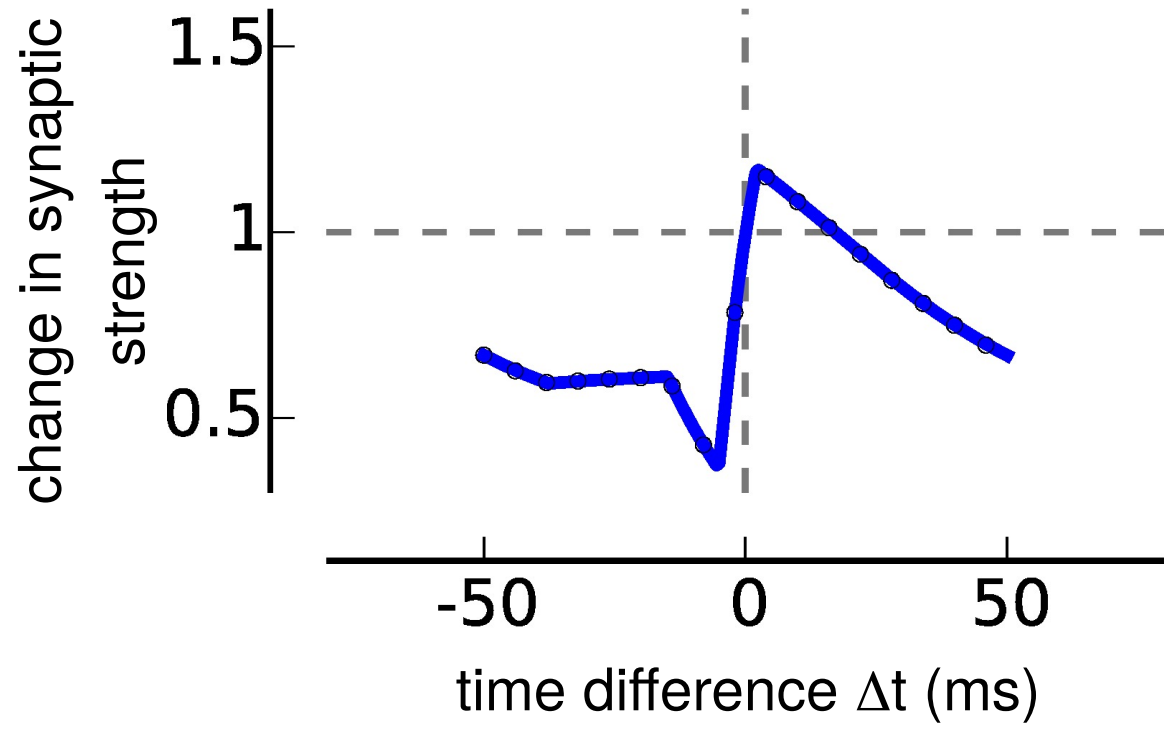
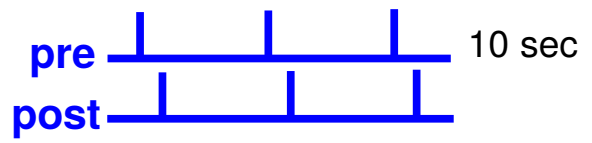

$$\nu_{\text{pre}} = \nu_{\text{post}} = 10 \text{ Hz}$$

Regular vs. irregular spike-pairs

regular spike-pairs

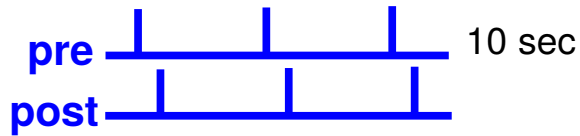

Poisson distributed spike-pairs

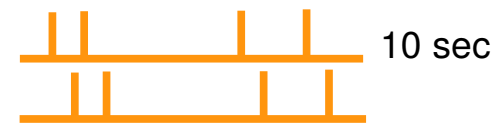

$$v_{\text{pre}} = v_{\text{post}} = 10 \text{ spk/sec}$$

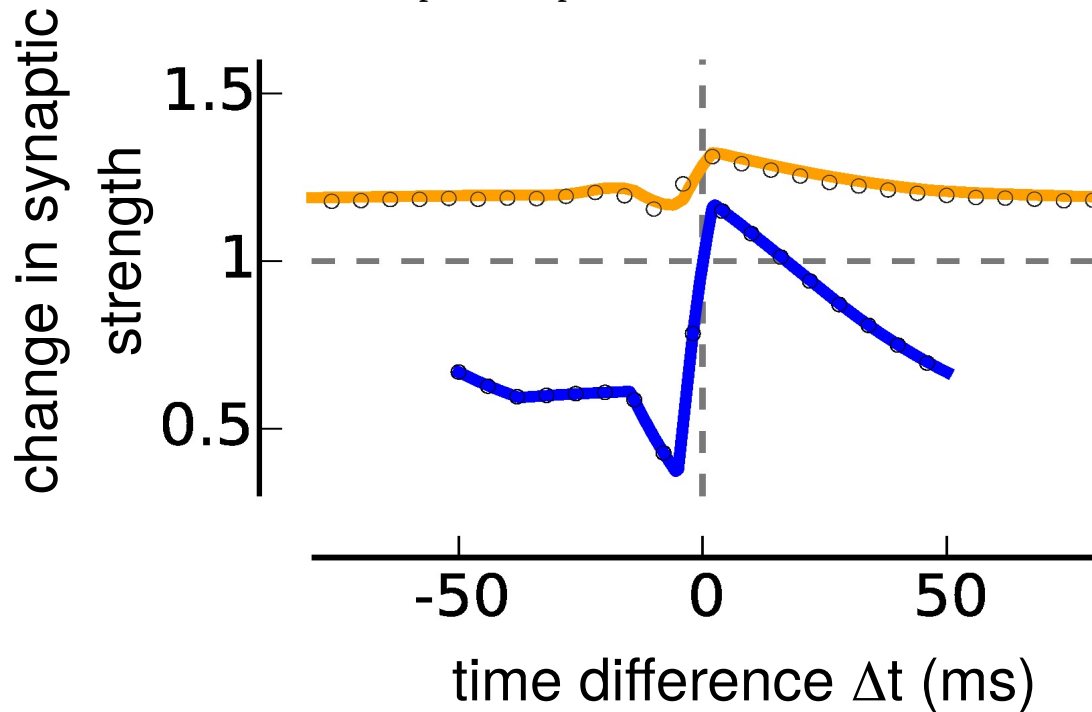

Irregular spike-pairs flatten STDP curve

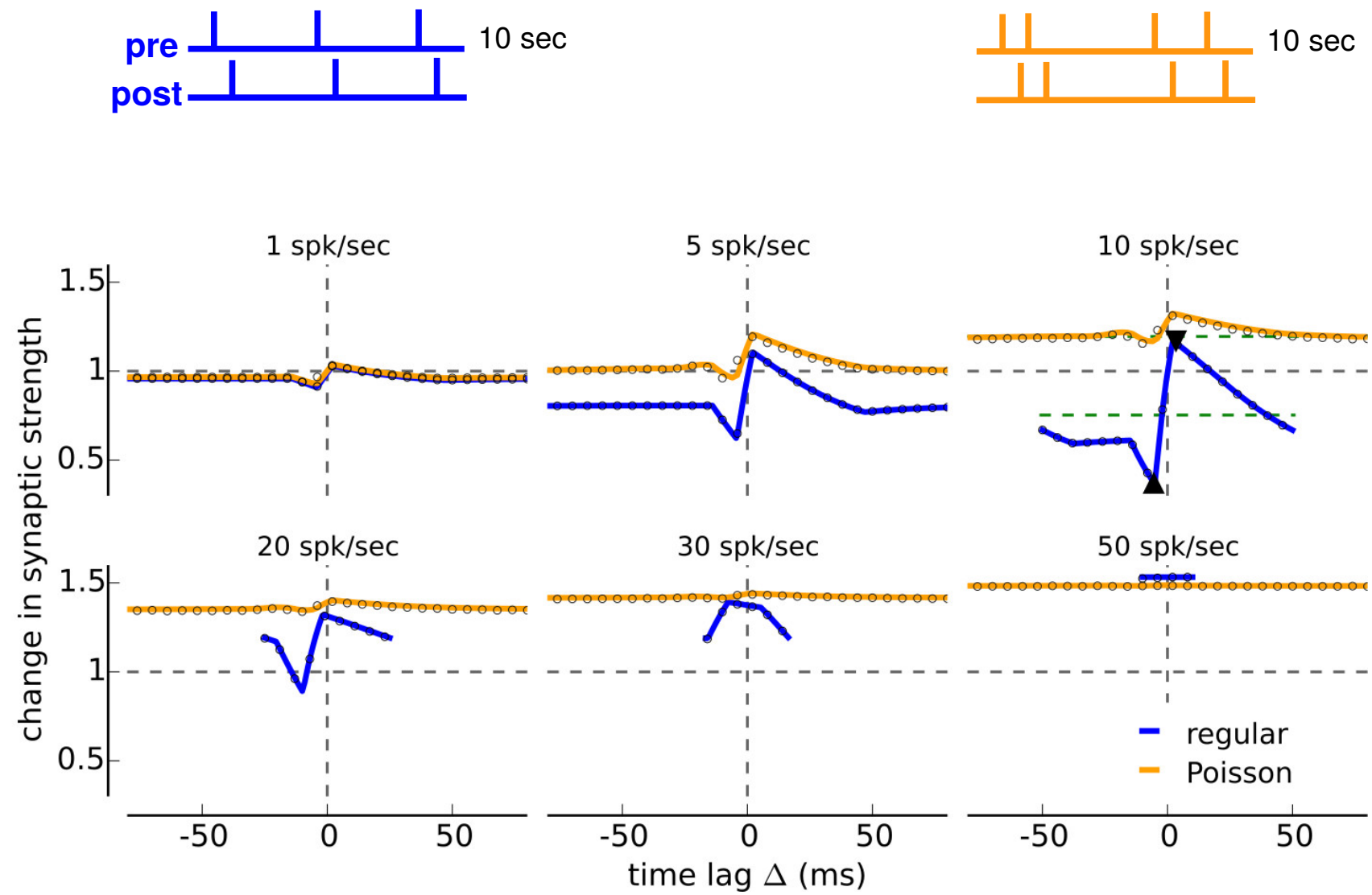

Conclusions

- STDP : temporally asymmetric form of synaptic plasticity induced by tight temporal correlations between the spikes of pre- and postsynaptic neurons
- induction: coincident pre- and postsynaptic activity lead to calcium influx through NMDA receptors, triggering intracellular signaling cascades
- biophysical models resolve various aspects of the synaptic machinery involved in plasticity induction, most commonly the postsynaptic calcium dynamics
- the role of STDP for learning in the living animal remains elusive

Diversity of STDP curves : spike-pair stimulation

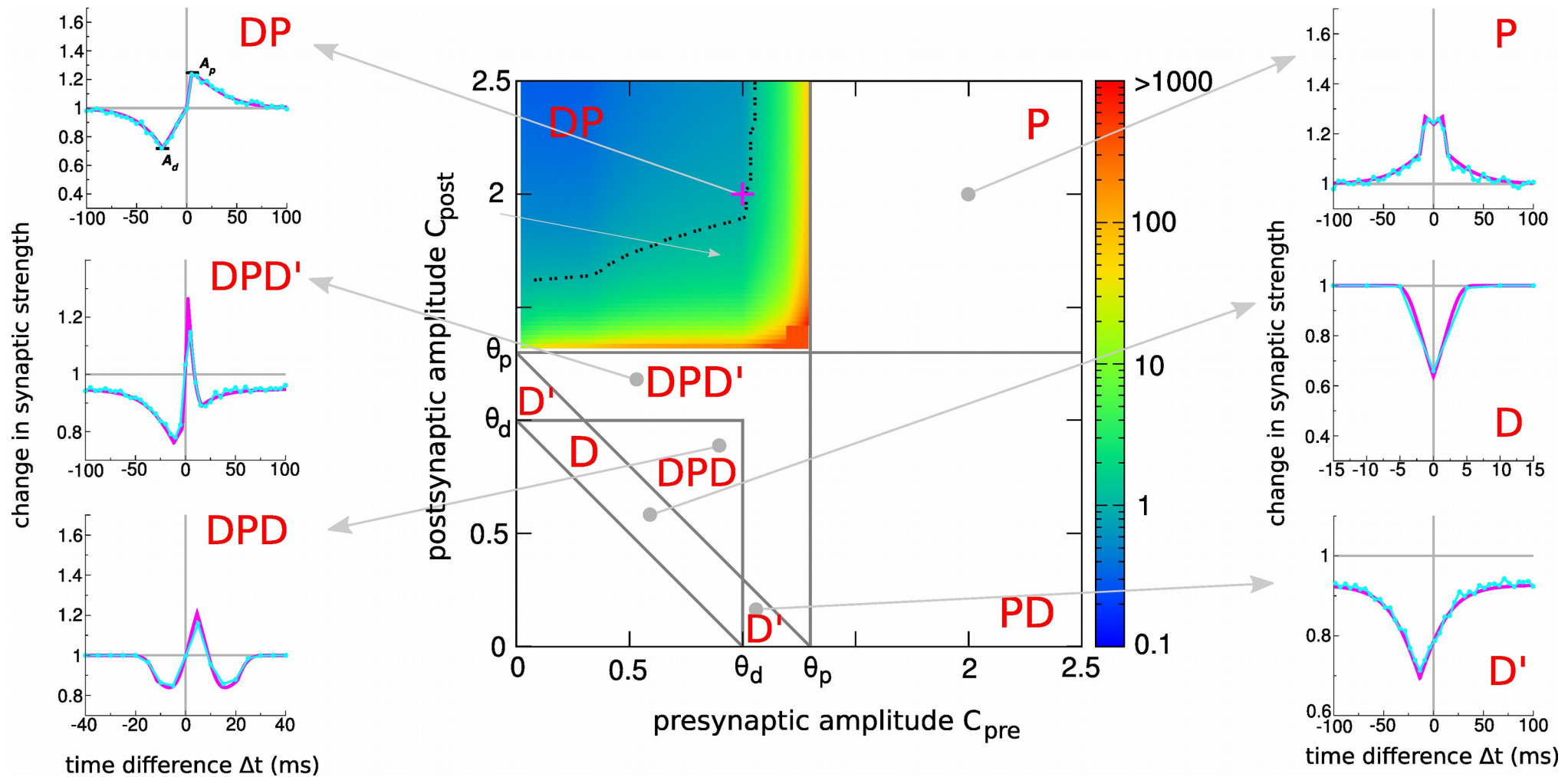

Malleability of hippocampal STDP explained by Ca^{2+}

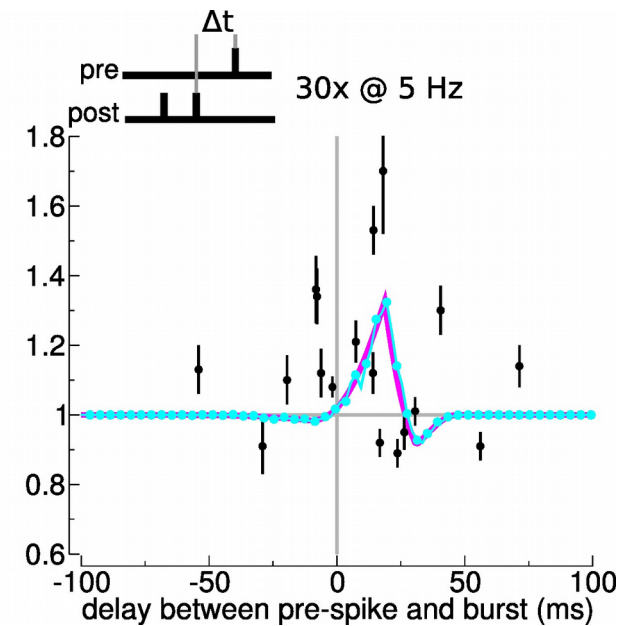
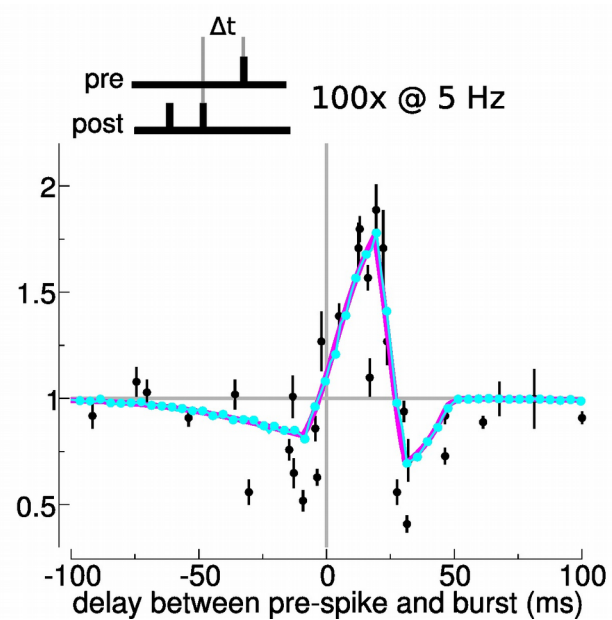
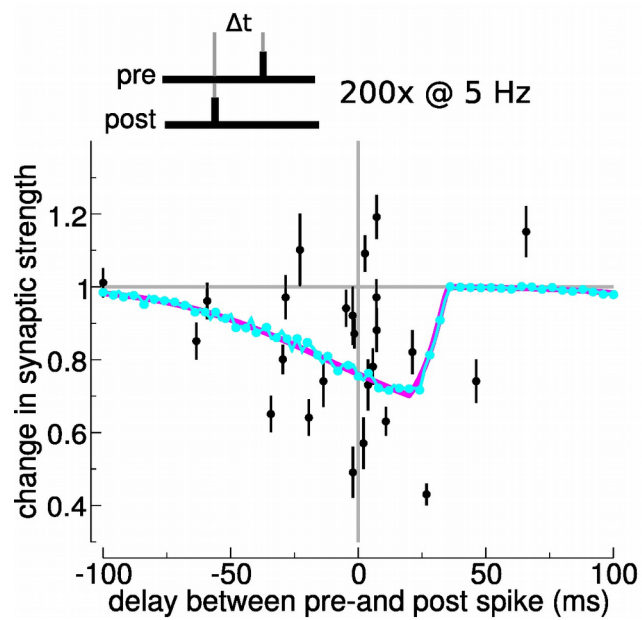

[Wittenberg & Wang, 2006]

Firing rate dependence in cortical slices

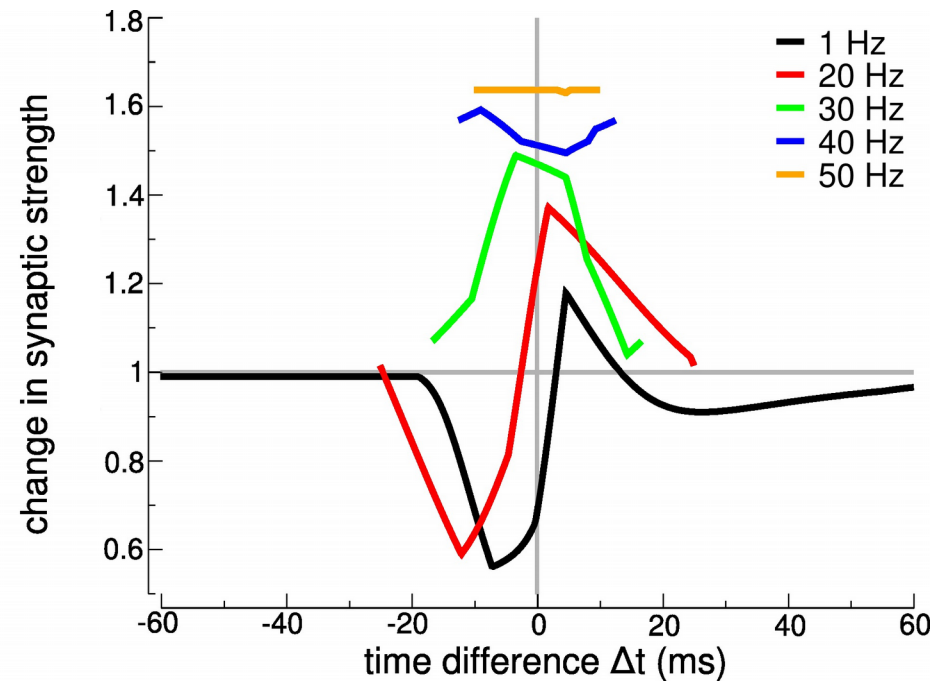
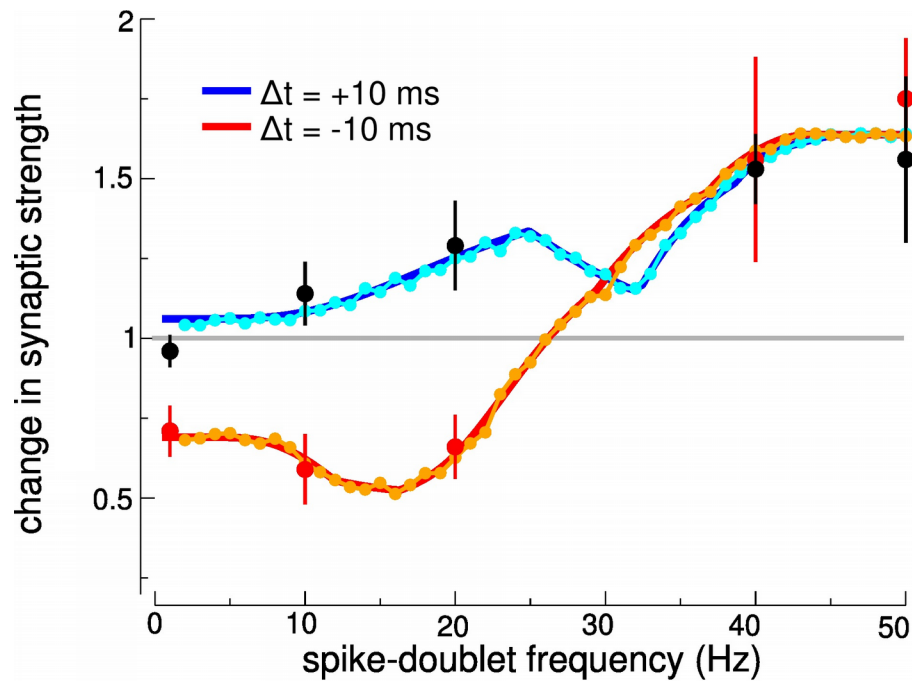
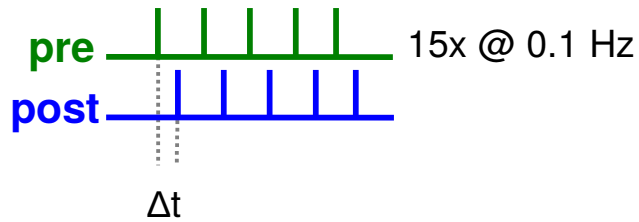

[Sjöström *et al.*, 2001]

Pharmacological manipulations explained by Ca^{2+}

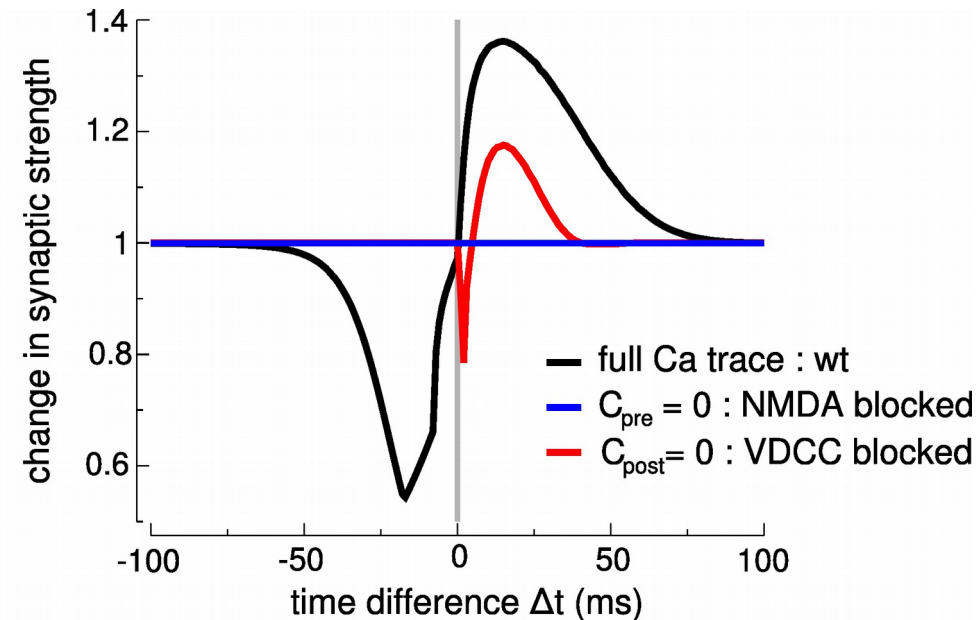
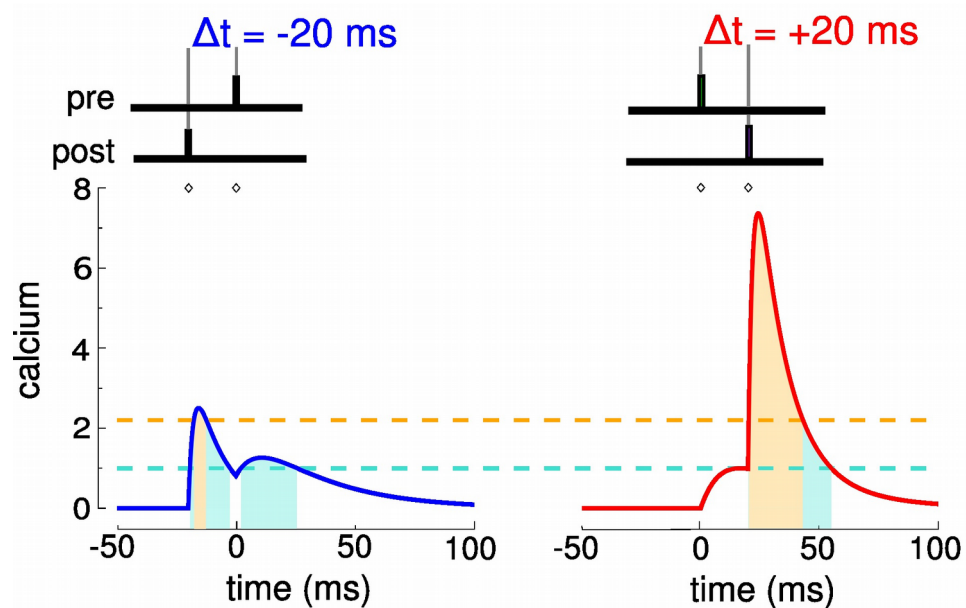

[Bi & Poo, 1998; Nevian & Sakmann, 2006]

- nonlinear, finite rise time calcium transients necessary to reproduced pharmacological block experiments

Study the effect of nootropic drugs (memory enhancer)

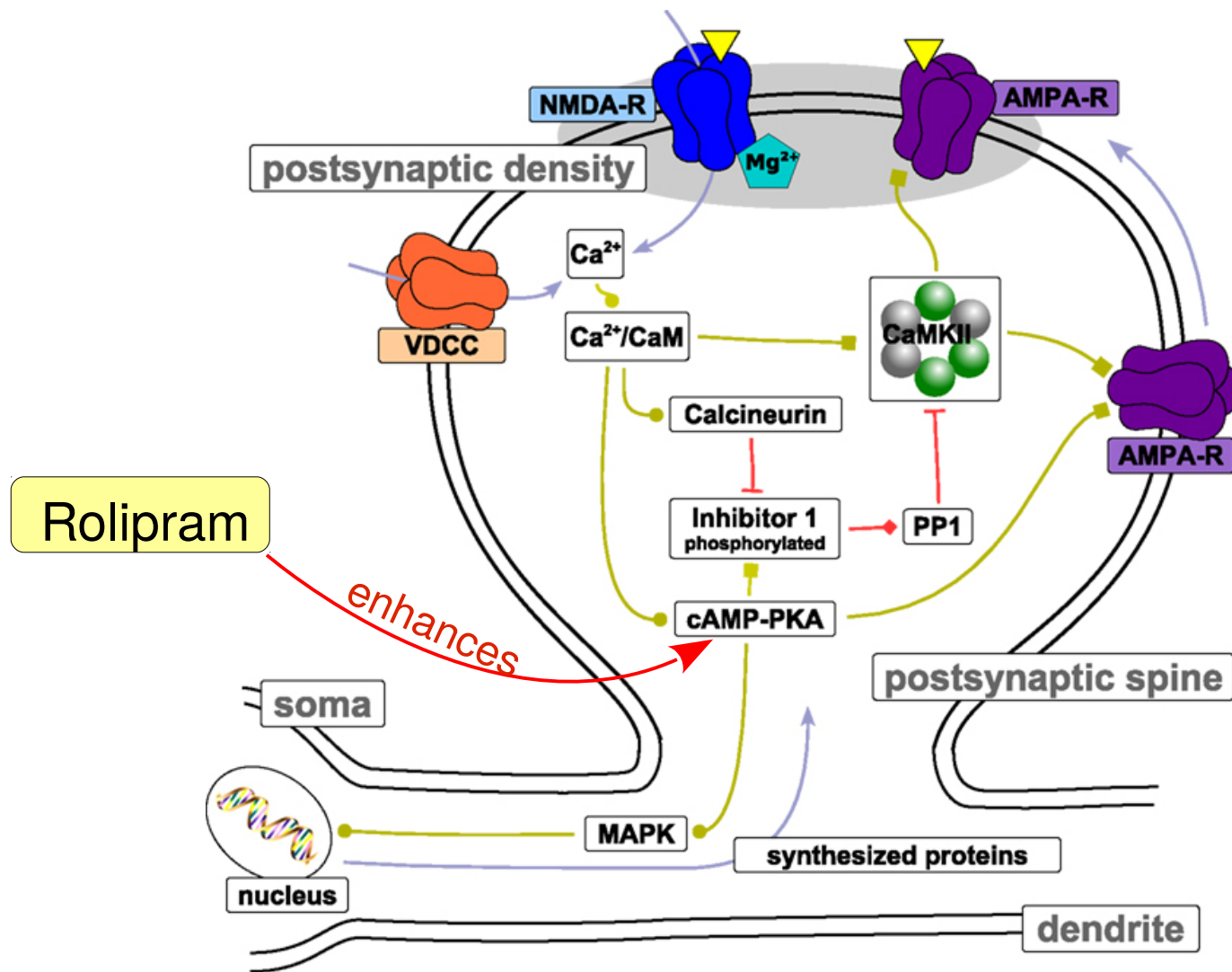

Rolipram ... selective phosphodiesterase-4 inhibitor

Study the effect of nootropic drugs

- boosting of cAMP during stimulation increases LTP

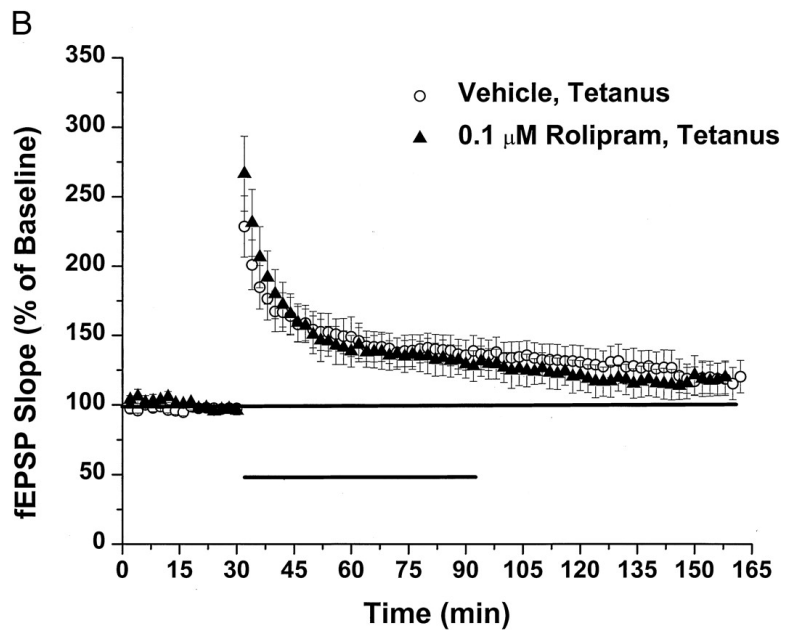
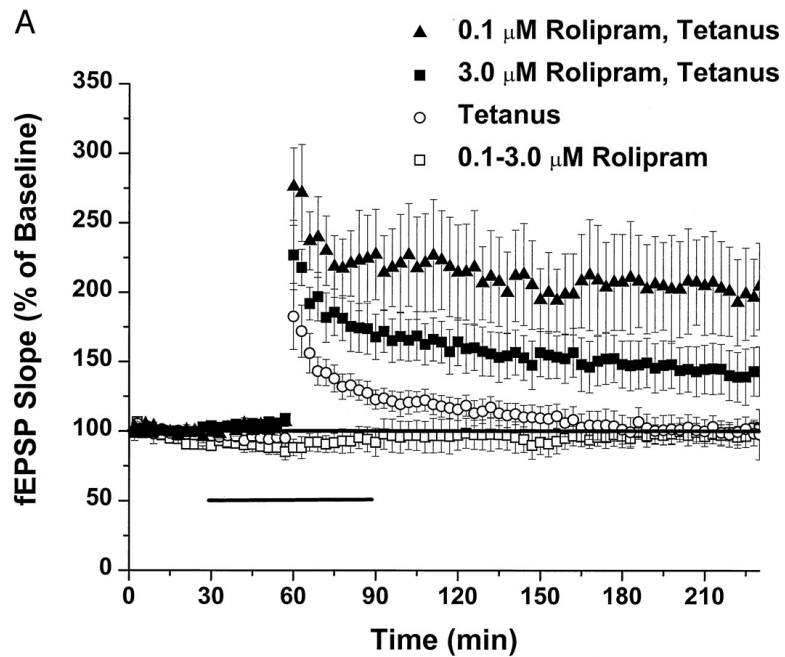

Study the outcome of nootropic drugs

- Rolipram enhances memory

