



Systems Neuroscience : Motor adaptation and sensory prediction in the Cerebellum

Michael Graupner (PhD)

*Saints-Pères Paris Institute for the Neurosciences
CNRS UMR 8003, Université de Paris*

Cerebellum

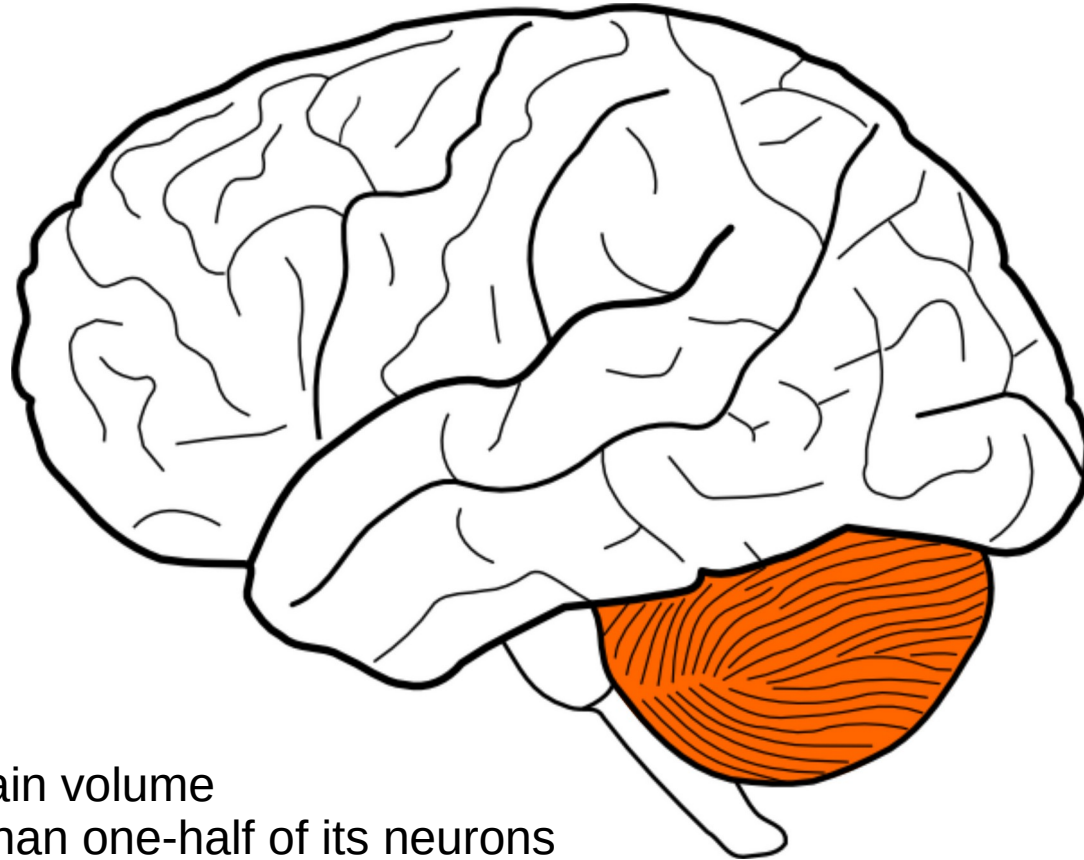

10 % of the total brain volume
but contains more than one-half of its neurons

Cerebellum

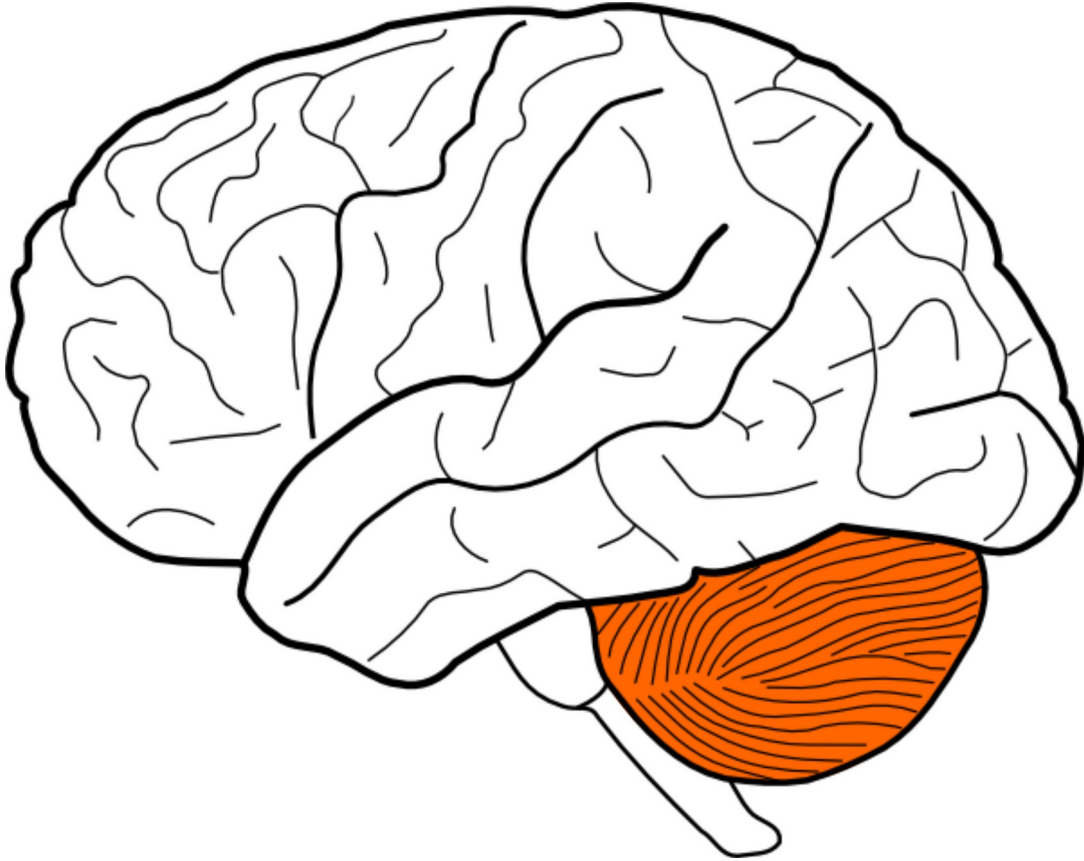

contains highly regular, repeating units with the same basic microcircuit

different regions receive inputs from different parts of the brain and project to different motor systems

similarity (architecture, physiology) suggests similar computational operations

Talk outline

1. Cerebellar disorders

- functions inferred from symptoms
- eye-arm movement coordination with prism glasses

2. Electric fish and prediction of sensory consequences

- anatomy and physiology of the weakly electric fish
- cerebellar circuitry
- cerebellum-like structures
- electric fish and prediction of sensory consequences

3. Sensory prediction and forward model

- sensory prediction in monkeys
- forward model and the cerebellum

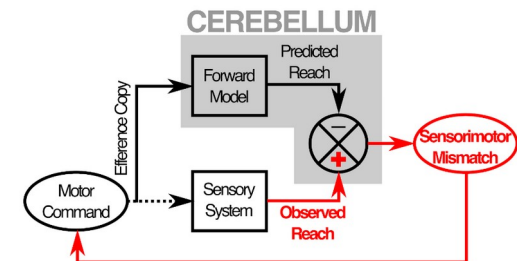
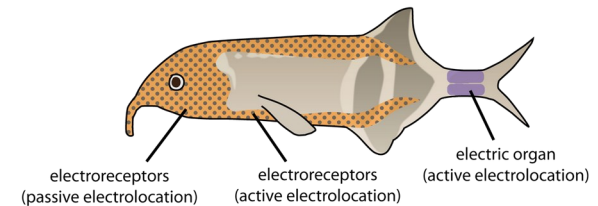
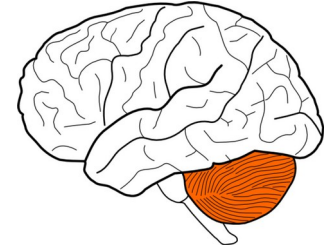

Talk outline

1. Cerebellar disorders

- functions inferred from symptoms
- eye-arm movement coordination with prism glasses

2. Electric fish and prediction of sensory consequences

- anatomy and physiology of the weakly electric fish
- cerebellar circuitry
- cerebellum-like structures
- electric fish and prediction of sensory consequences

3. Sensory prediction and forward model

- sensory prediction in monkeys
- forward model and the cerebellum

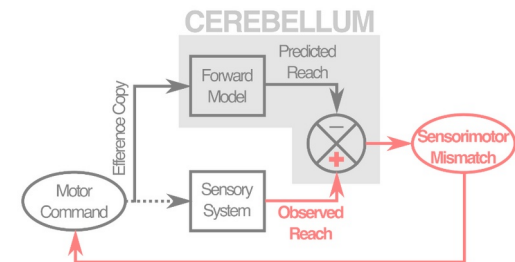
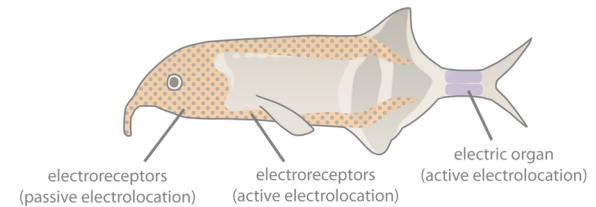
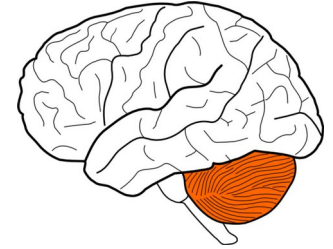

Cerebellum controls movement

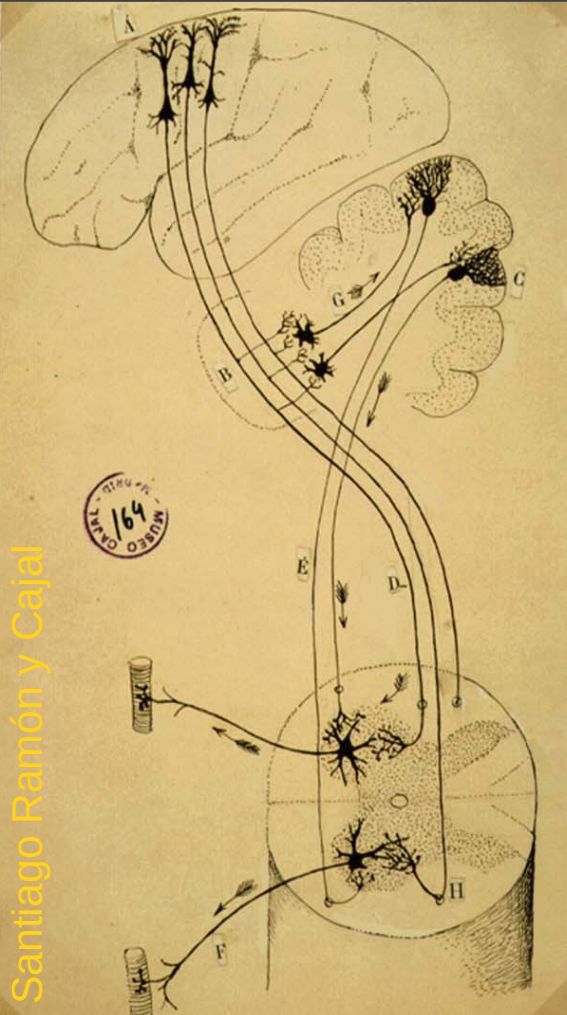

Classical view :

Cerebellum *participates* in the control of movement.
The cerebellum ensures that movements are well timed and highly coordinated.

Inferred from cerebellar damage in humans :

Disorders result in disruptions of normal movement.

Goal of cerebellar research :

How to the connections and physiology of cerebellum define the role in motor control.

Symptoms of cerebellar disorders

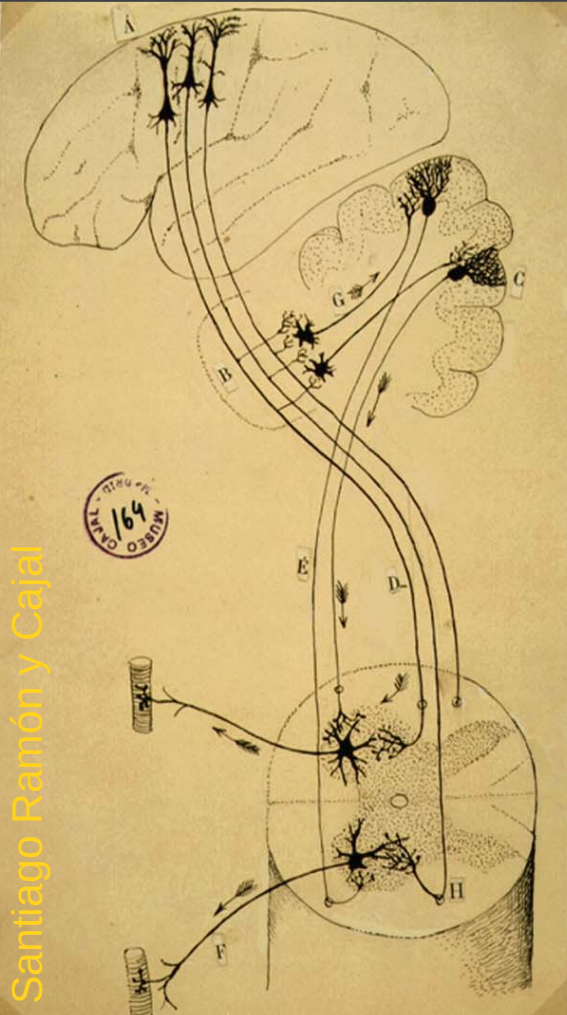

Hypotonia :

diminished resistance to passive limb displacement

Astasia-abasia :

inability to maintain steady limb or body posture across multiple joints - inability to maintain upright stance against gravity

Ataxia :

abnormal execution of multi-joint voluntary movements, lack of coordination

Action tremor :

tremor at the end of movement

Symptoms of cerebellar disorders

Patient with cerebellar ataxia

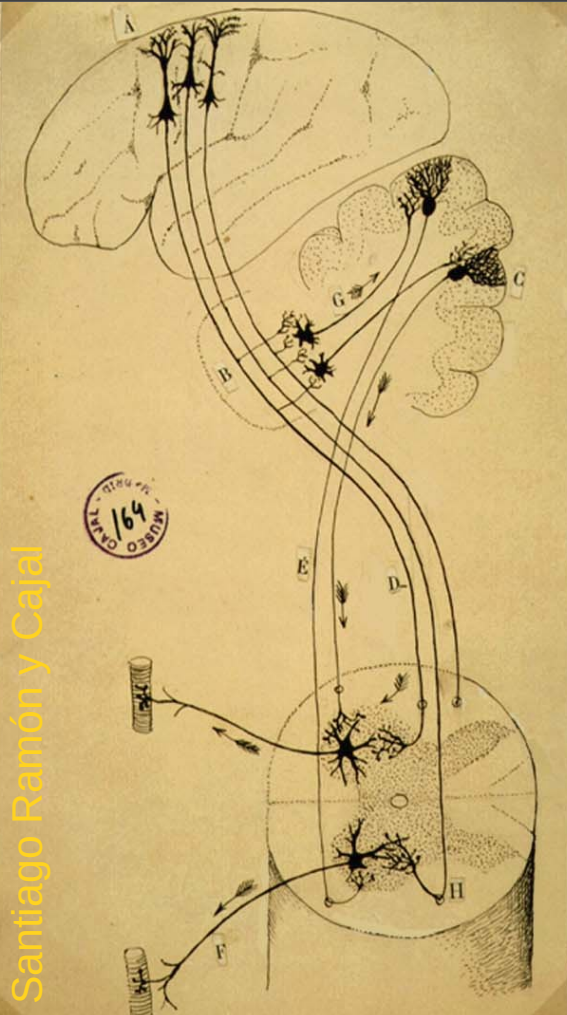

Derived functions of the cerebellum

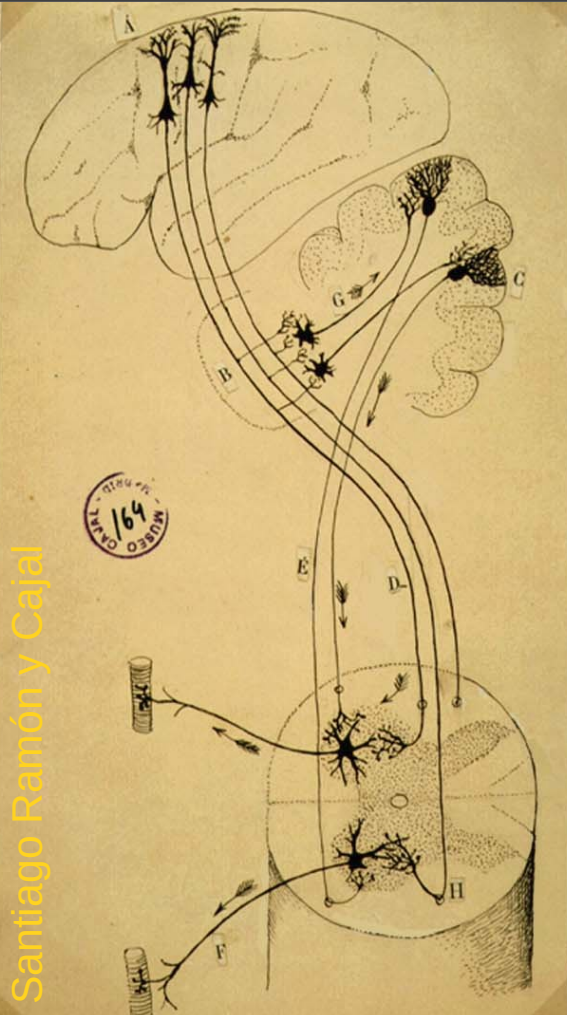

- Initiation and control of voluntary movements
- Timing of movement/muscle action
- Moment-to-moment corrections of errors
- Compensating for lesions of the cerebral cortex
- Motor learning and adaptive adjustments

What is movement ?



sensory and motor inputs are integrated to generate appropriate activation of muscle and joint combinations

Prism glasses



- experimental paradigm to study the learning of a synergy between vision and motor output
- adaptation of the eye-hand coordination when wearing prism goggles

[experiment]

Prism glasses



- humans usually fixate a target and throw in the direction of the gaze
- relationship between the direction of the gaze and arm movement is adjustable

Throwing while looking through prisms

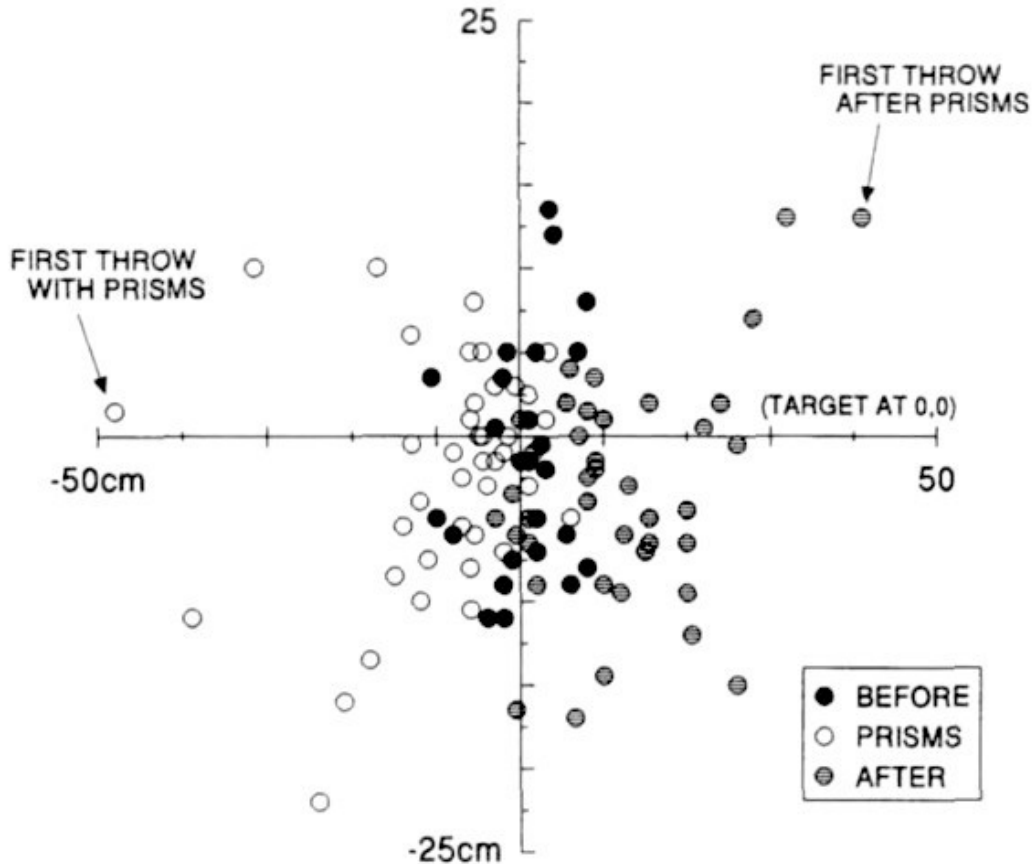

- The initial throw in the direction of gaze misses target to the side by an amount proportional to the diopter of the prism (in our case 30 %)
- subject gradually increase angle between gaze and throw to land on target again
- after glasses are removed, gaze is on target, but the widened angle btw. gaze and throw persists; this 'negative after-effect' diminished with repeated throws

Throwing while looking through prisms

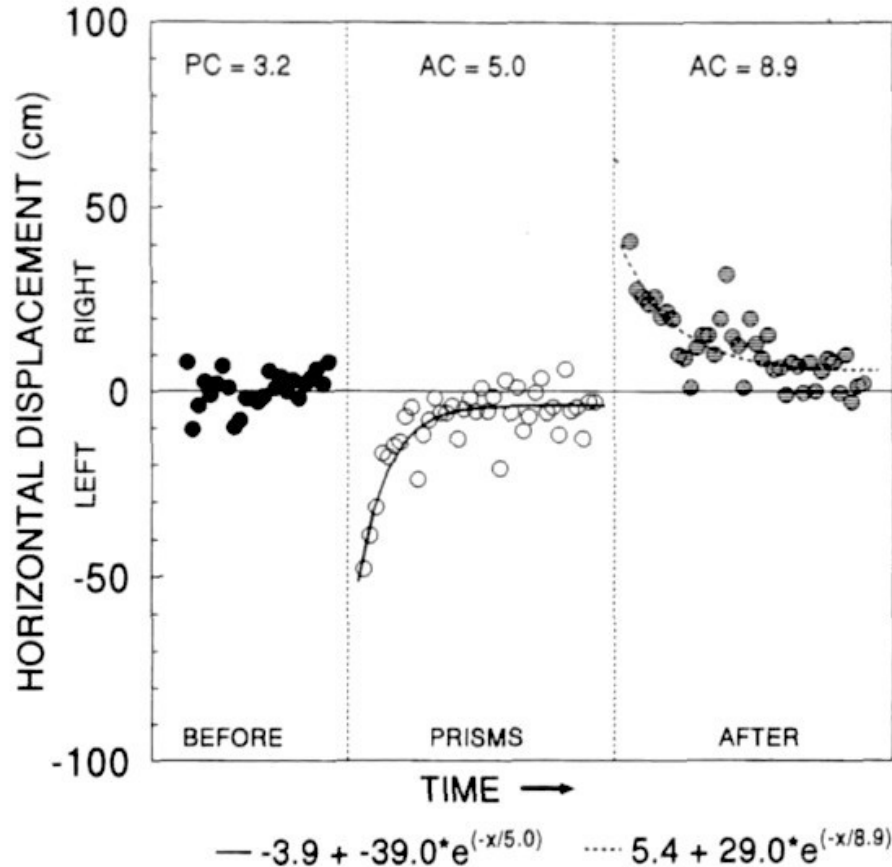

- The initial throw in the direction of gaze misses target to the side by an amount proportional to the diopter of the prism (in our case 30 %)
- subject gradually increase angle between gaze and throw to land on target again
- after glasses are removed, gaze is on target, but the widened angle btw. gaze and throw persists; this 'negative after-effect' diminished with repeated throws

Cerebellar patients : throwing while looking prisms

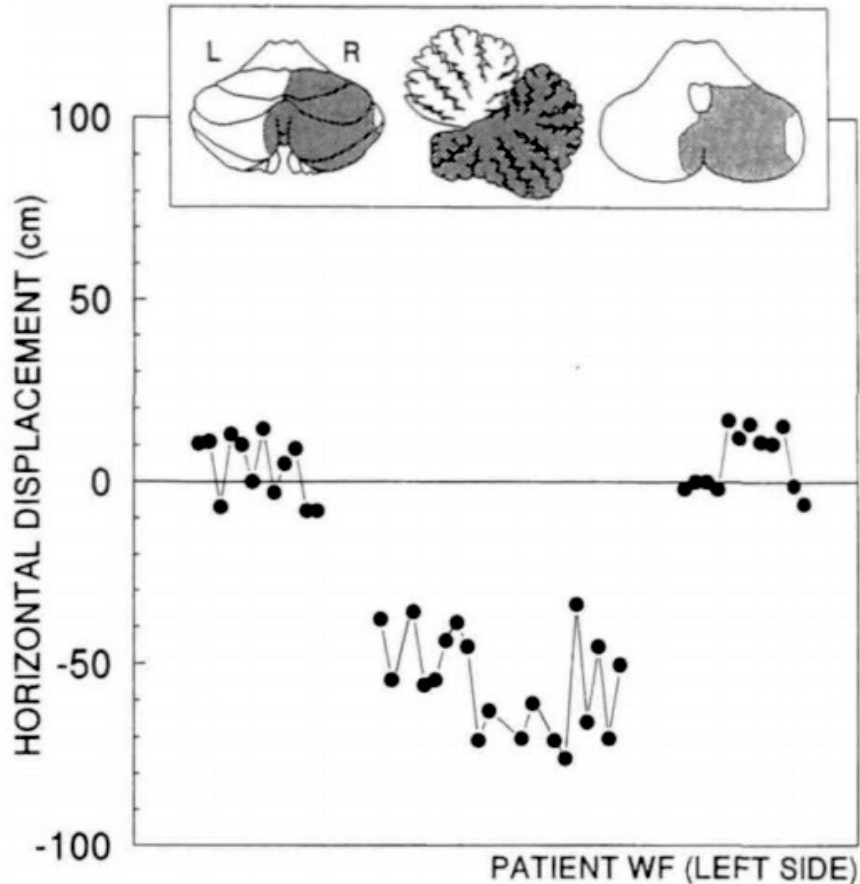

- patients with cerebellar disorders show slow or no adaptation of the eye-hand
- example on the left : patient with right sided infarct of the posterior inferior cerebellar artery

Talk outline

1. Cerebellar disorders

- functions inferred from symptoms
- eye-arm movement coordination with prism glasses

2. Electric fish and prediction of sensory consequences

- anatomy and physiology of the weakly electric fish
- cerebellar circuitry
- cerebellum-like structures
- electric fish and prediction of sensory consequences

3. Sensory prediction and forward model

- sensory prediction in monkeys
- forward model and the cerebellum

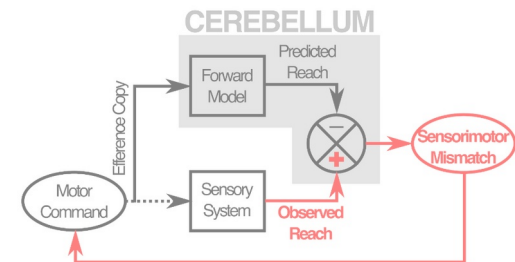
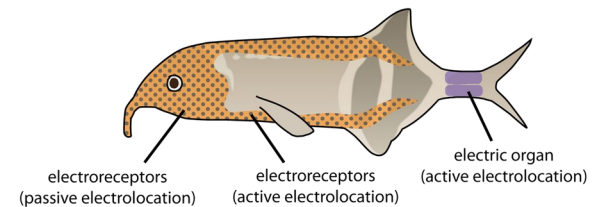
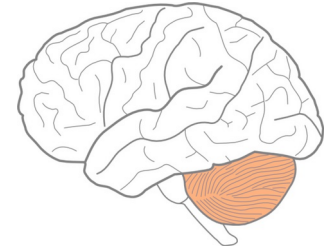

African weakly electric mormyrid fish

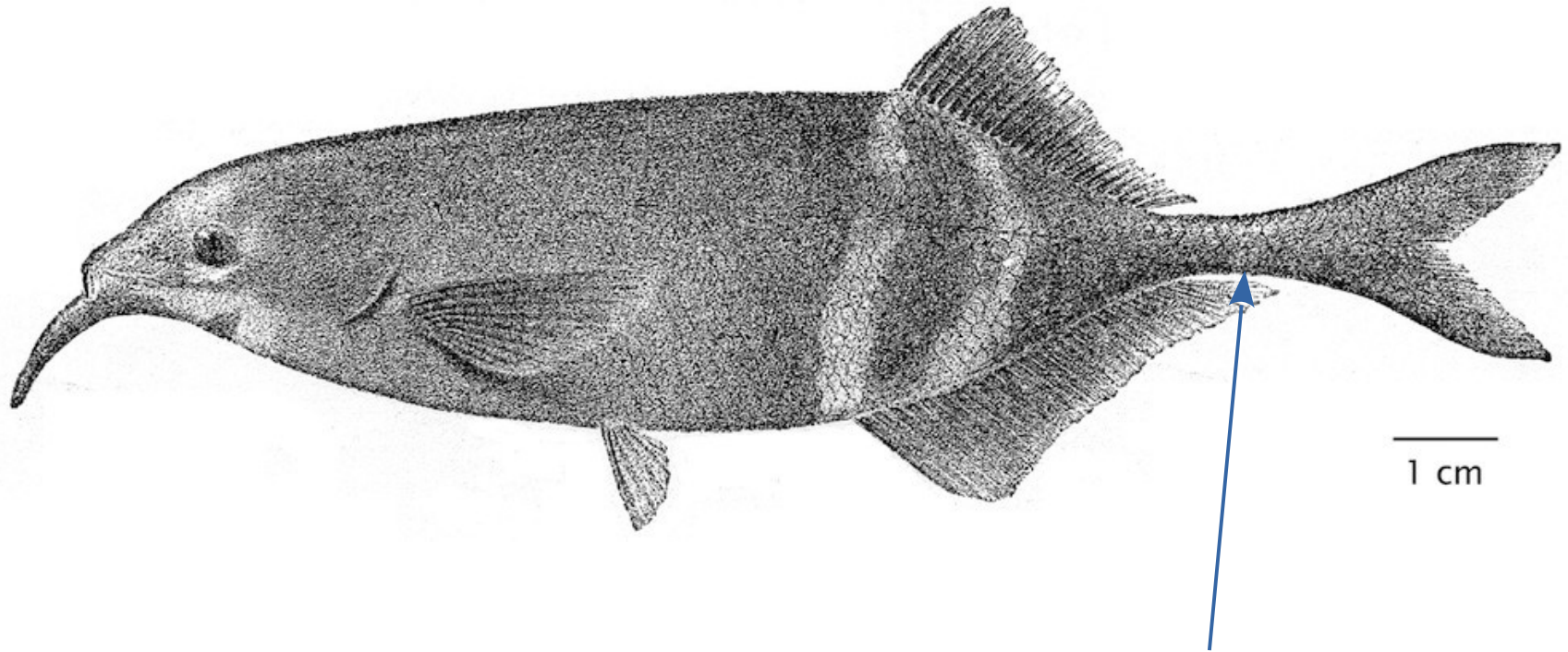

- possess electroreceptors on their skin that are sensitive to weak, low-frequency electrical fields in the environment
- additionally has specialized organ (typically located in the tail) that generates a weak electrical field known as an electric organ discharge (**EOD**)

African weakly electric mormyrid fish

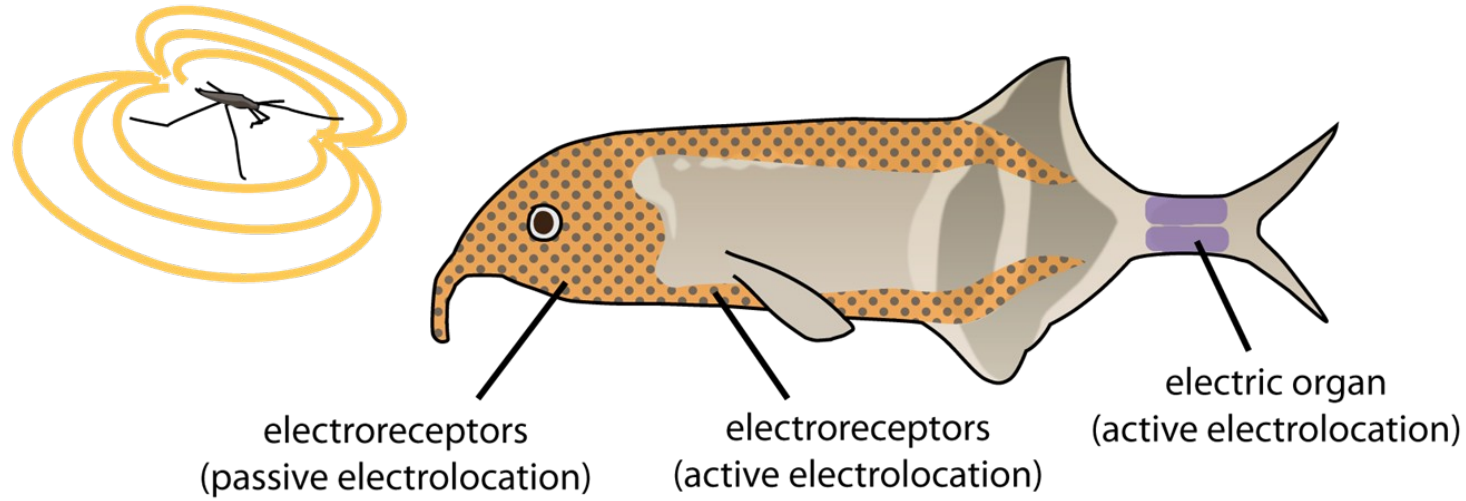

- Active and passive electrolocation are mediated by separate classes of electroreceptors

- electric organ discharge (**EOD**) used to sense environment and communicate (like whisking in rodents)
- 2-4 /s in resting-, 10-30 /s in moving fish

Electric organ discharge : usage

- Active and passive electrolocation are mediated by separate classes of electroreceptors; 3 receptor classes in total

electrolocation

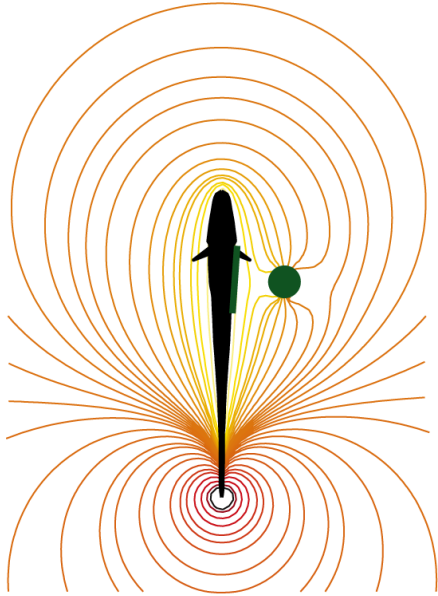

1) mormyromast : active electrolocation

electrocommunication

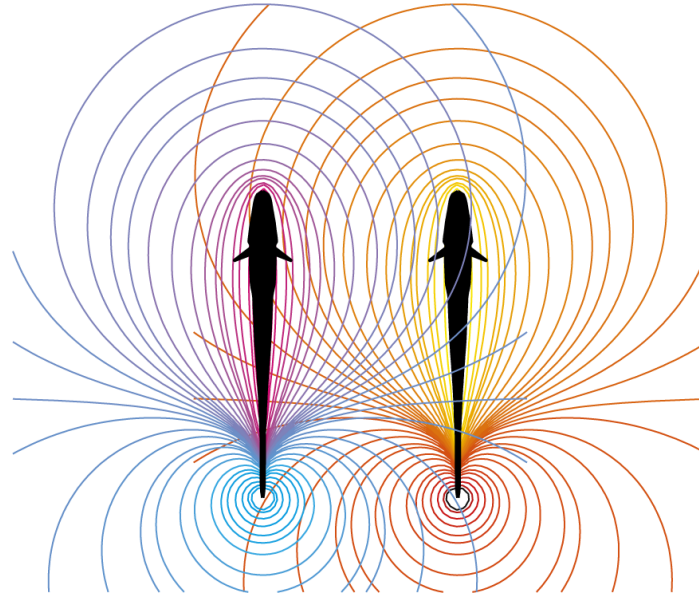

2) Knollenorgan : detecting EOD of other fish

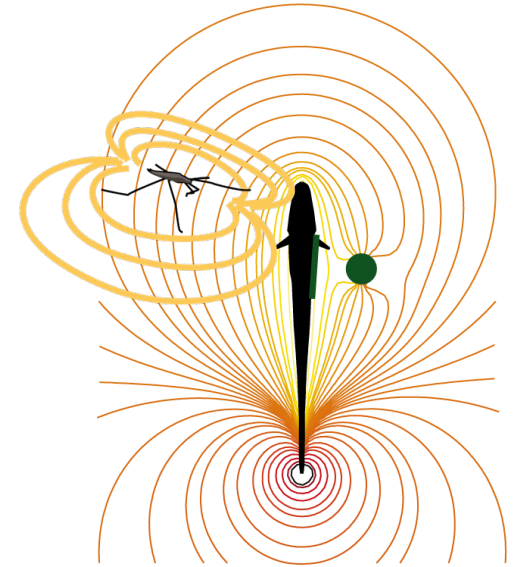

3) ampullary : can measure weak electric fields that all animals generate in water

Challenge for the fish

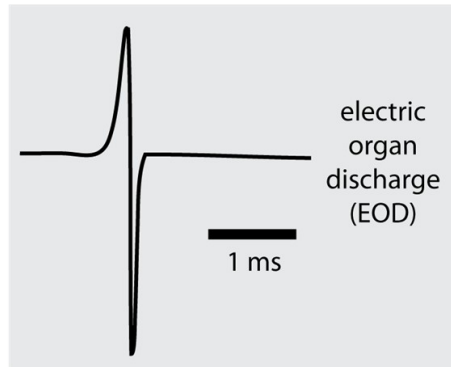
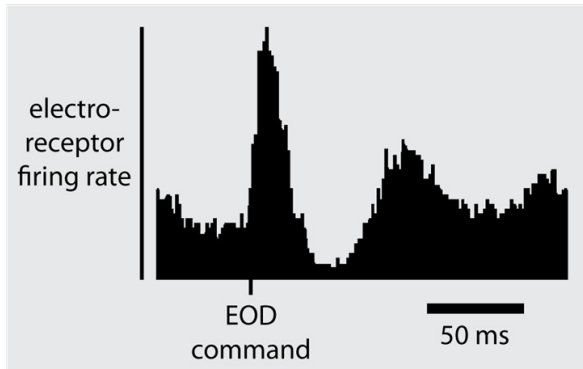
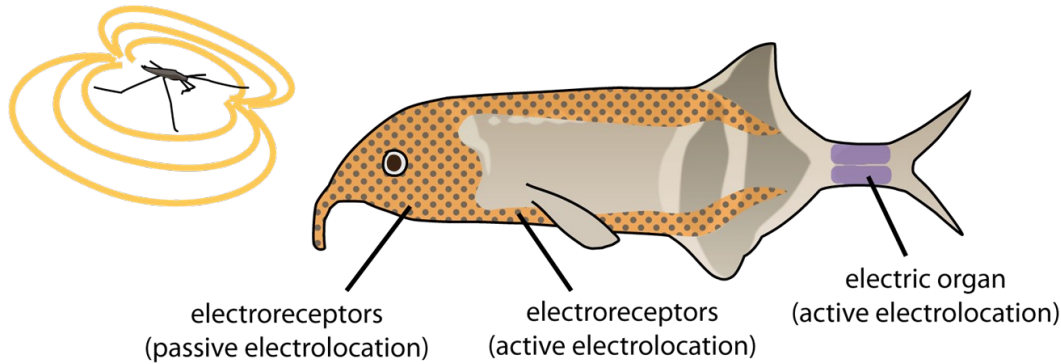

- **problem** : passive (ampullary) electroreceptors are strongly affected by the fish's own EOD pulse
- **possible solution** : external and self-generated input can be distinguished based on additional information about own movement and behavior
- **implementation** : convergence of two distinct input streams – peripheral electrosensory input *and* information about own movement and behavior

Challenge for the fish and others species

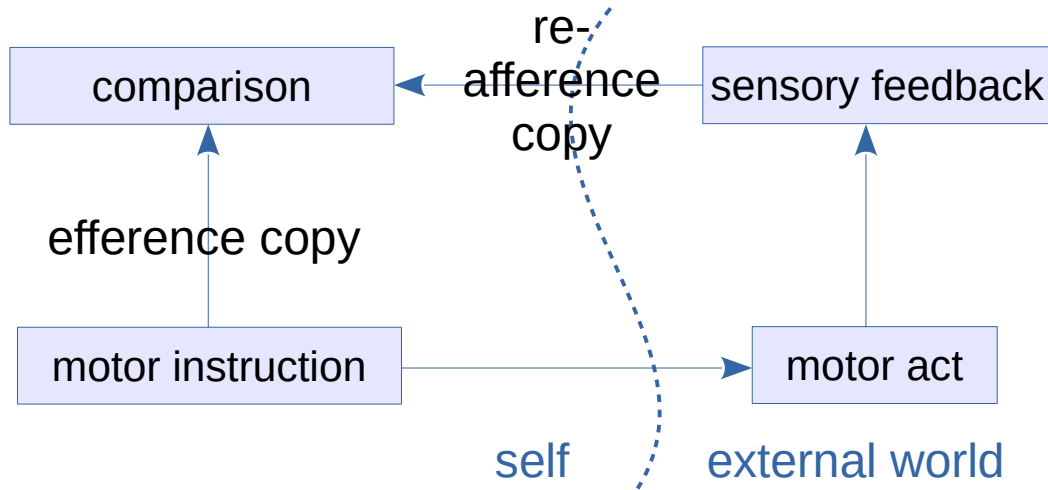

- every motor act will elicit sensory inputs (called reafference)
- reafference can be disruptive because it can interfere with sensing of external stimulus sources
- problem can be solved with signals from the motor command center to appropriate sensory receiving areas that nullify the effect of the unwanted reafference
- these signals are called efference copies/corollary discharges
- appropriate summation (negative image) of efference copy and reafference could reduce reafference effect
- requires implementation of an adaptive filter which removes predictable features of the sensory input

Challenge for the fish and others species

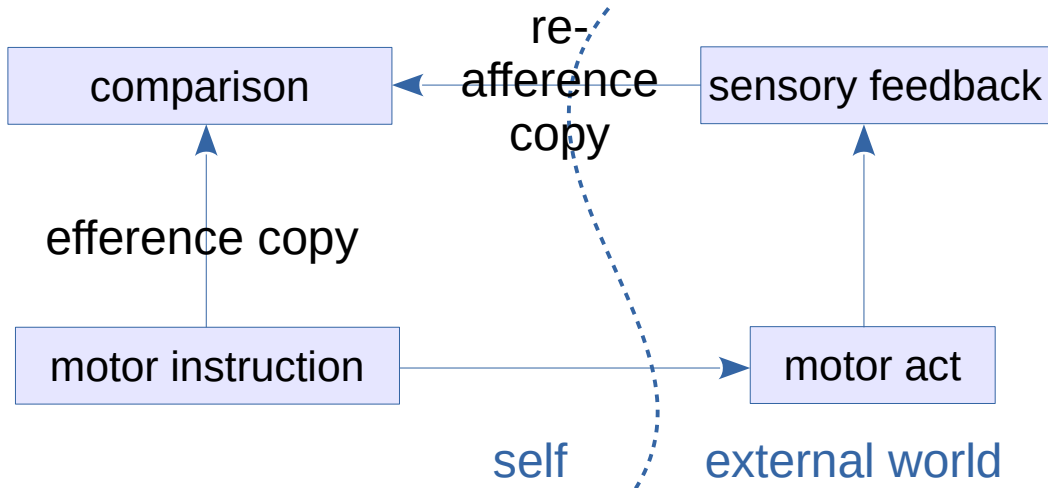
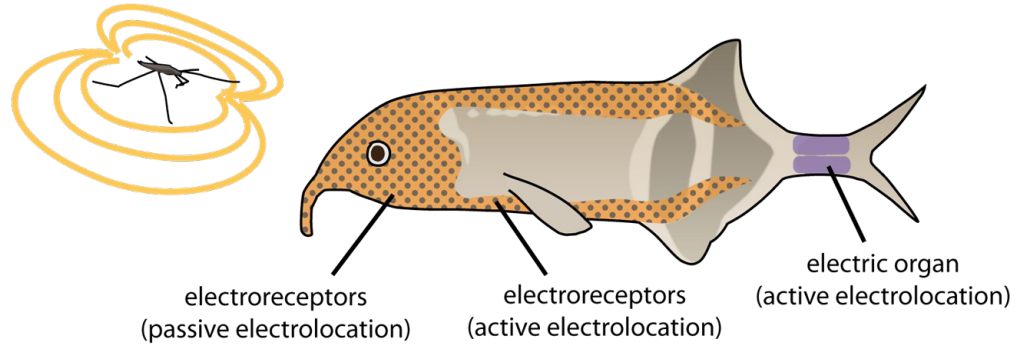

- every motor act will elicit sensory inputs (called refference)
- refference can be disruptive because it can interfere with sensing of external stimulus sources
- problem can be solved with signals from the motor command center to appropriate sensory receiving areas that nullify the effect of the unwanted refference
- these signals are called efference copies/corollary discharges
- appropriate summation (negative image) of efference copy and refference could reduce refference effect
- requires implementation of an adaptive filter which removes predictable features of the sensory input

Microcircuit organization of the cerebellar cortex

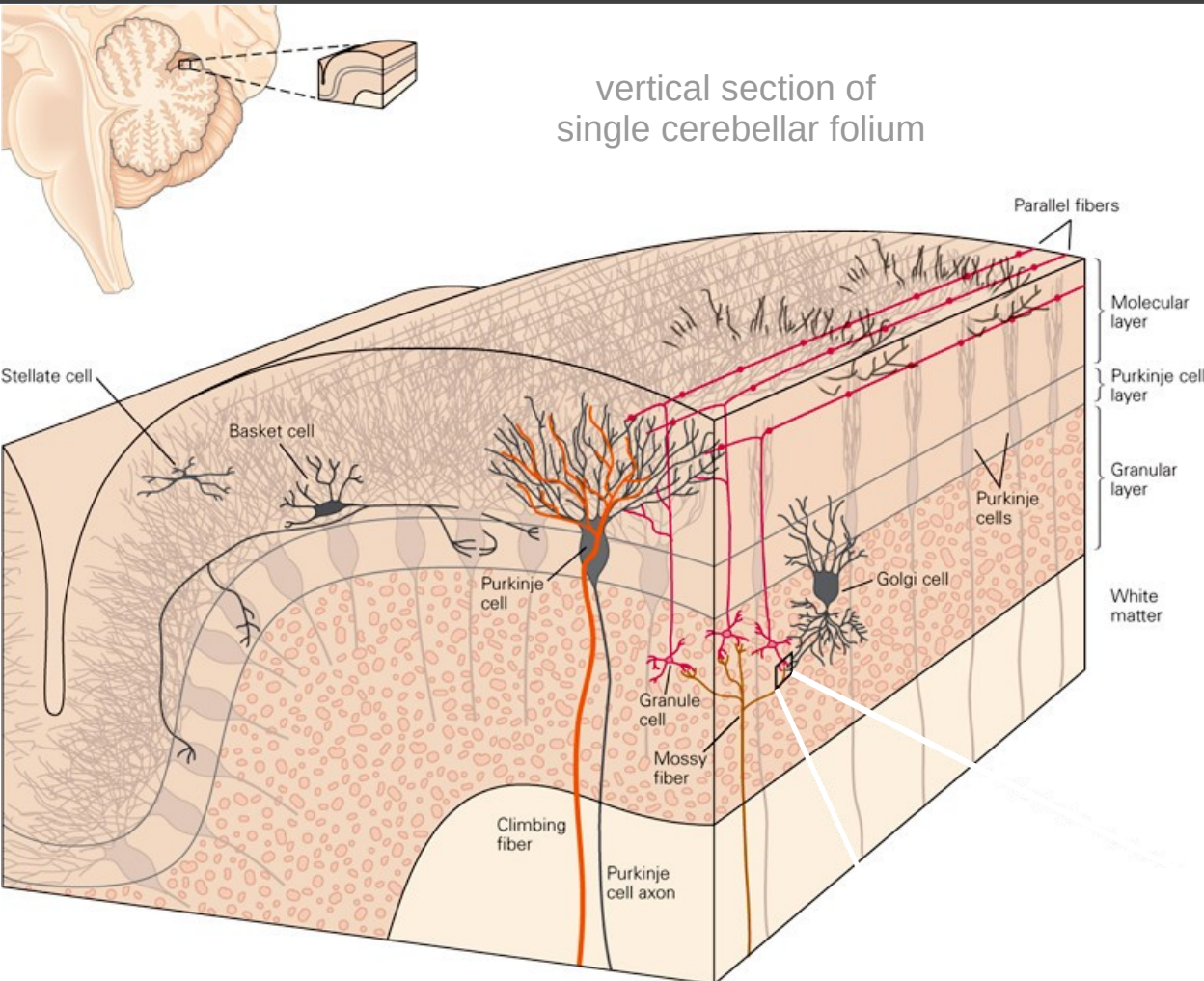

cerebellar cortex : five types of neurons organized in three layers

- *granular layer* : input layer, vast number of granule cells and Golgi interneurons; mossy fibers terminate in this layer
- *Purkinje cell layer* : output layer of the cerebellar cortex; input from parallel fibers, Stellate and Basket cells and climbing fibers
- *molecular layer* : inhibitory neurons; axons of granule cells - parallel fibers

Synaptic organization of the cerebellar microcircuit

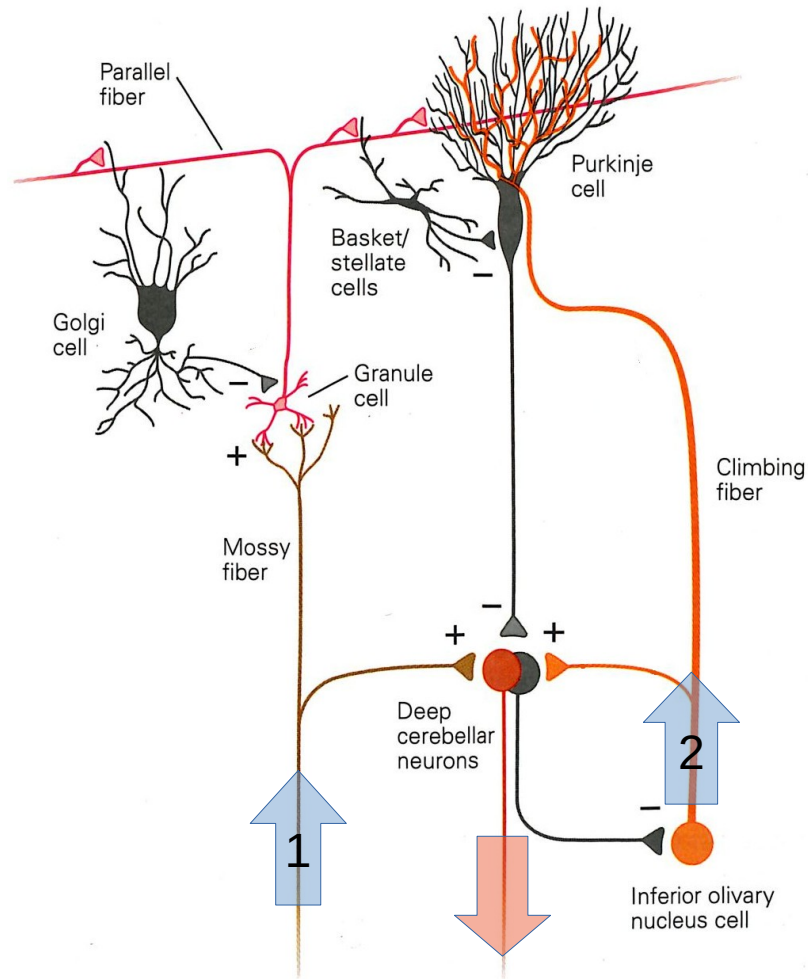

Two afferent fiber systems encode information differently

- 1. *mossy fibers* : from cells in spinal cord and brain stem, carry sensory information about periphery and cerebral cortex
- 2. *climbing fibers* : originate in inferior olivary nucleus and convey sensory information from periphery and cerebral cortex

Differences in the two input streams

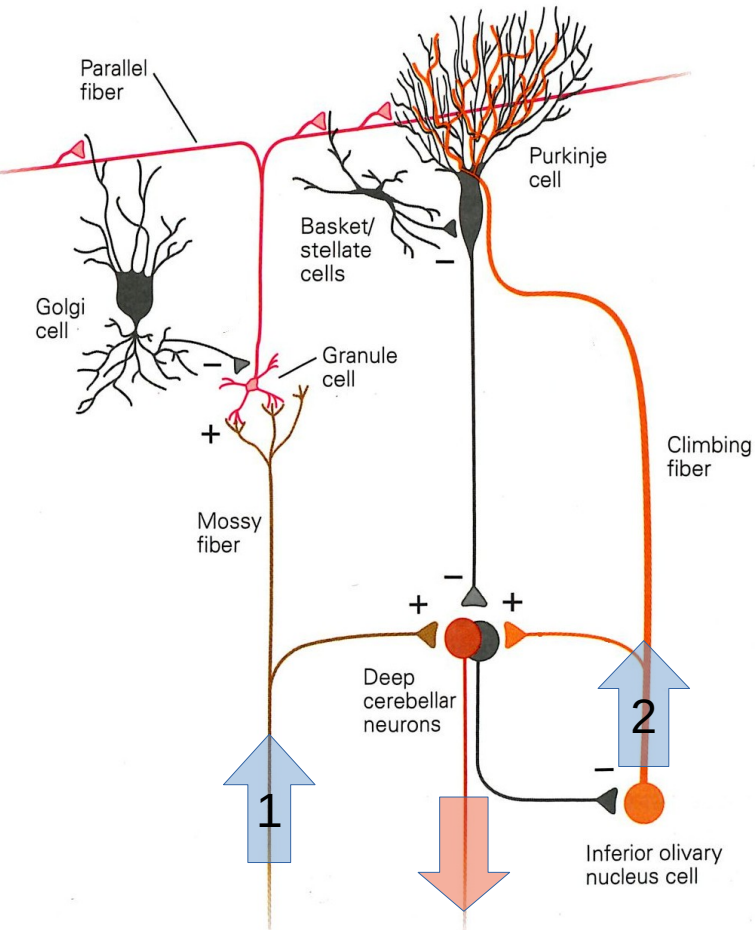

1. mossy-parallel fibers

- convergence (mossy fiber to granule cell) and divergence (parallel fiber run across long distances) of signal flow
- produce brief, small excitatory events → simple spikes; inputs from many needed to have substantial effect on PC firing rate
- encodes magnitude and duration of peripheral stimuli or behaviors

2. climbing fibers

- specific connectivity : arranged topographically btw. inferior olive, PCs in parasagittal strips, deep nuclear neurons
- powerful influence on PC activity → complex spike
- seems specialized for event detection; synchronous activation signal important event

Cerebellum-like structures

dorsal octavolateral nucleus
(fish: sharks, rays, and skates)

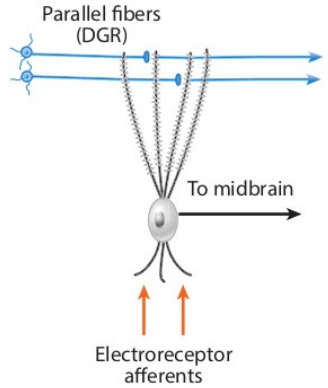

Mormyrid ELL

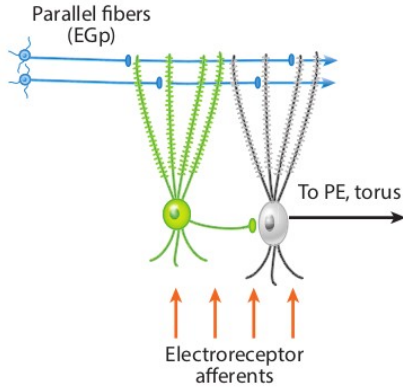

Gymnotid ELL

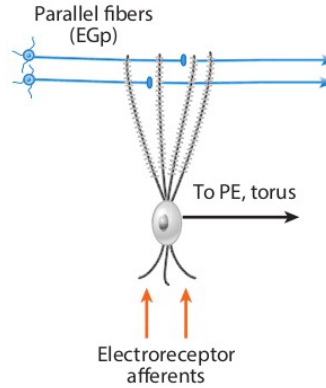

dorsal cochlear nucleus
(mammals, auditory system)

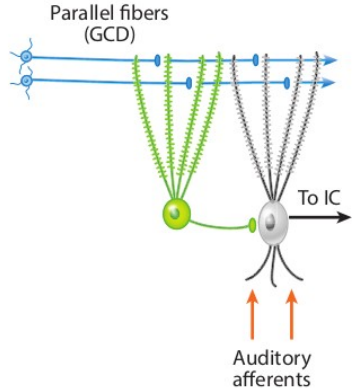

Teleost cerebellum

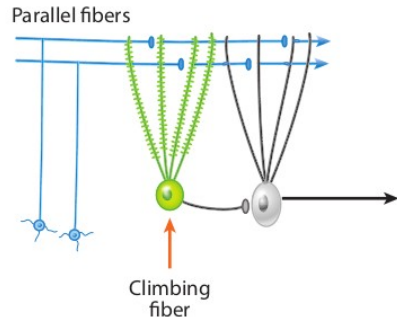

Mammalian cerebellum

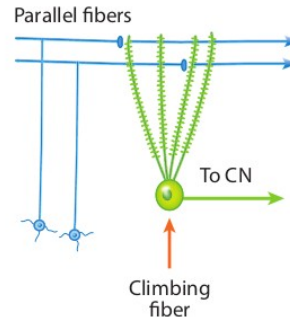

- presence of two input streams is the defining feature of the cerebellum(-like) structures from fish to mammals
- all have principal cells, stellate cells and granule cells
- For all of the circuits shown, signals conveyed by parallel fibers can be used to predict signals from the sensory periphery or from climbing fibers

Cerebellum-like structures

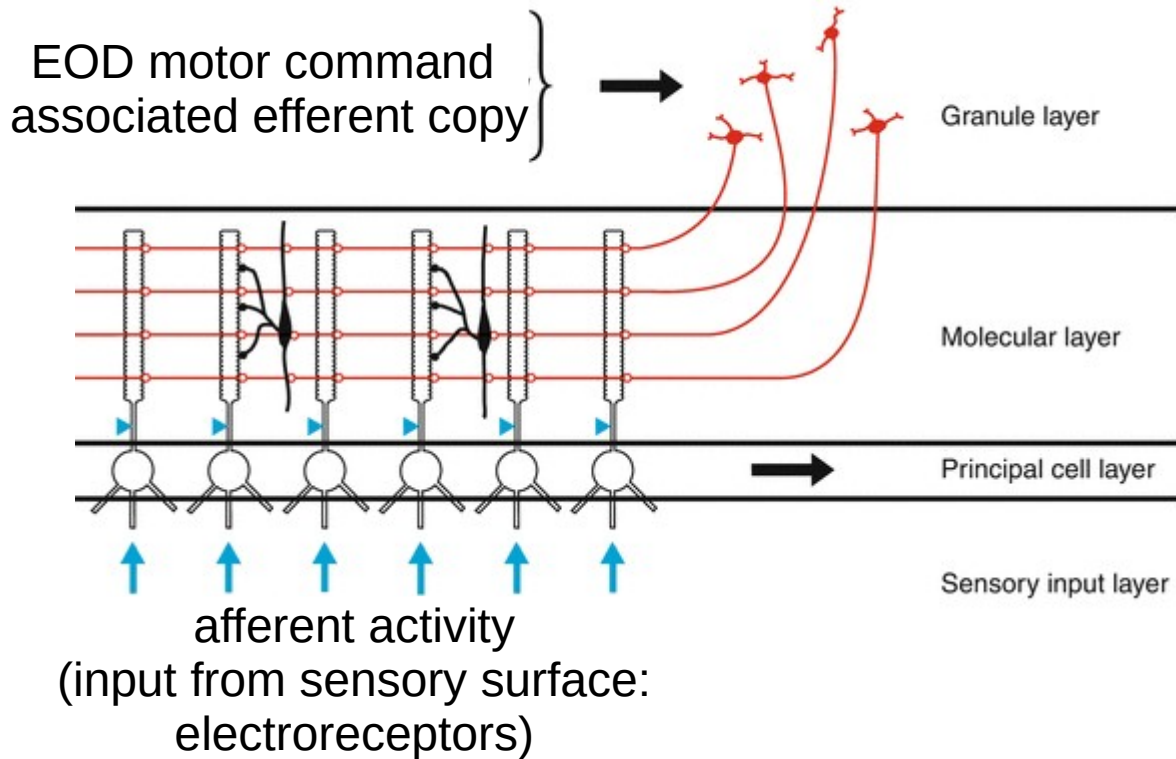

Granule cells:

convey efference copy that is associated with the motor command that causes the EOD

Principal cells:

also receive afferent activity :
sensory input from electroreceptors

Electric fish experiment: Bell 1982 J Neurophysiol

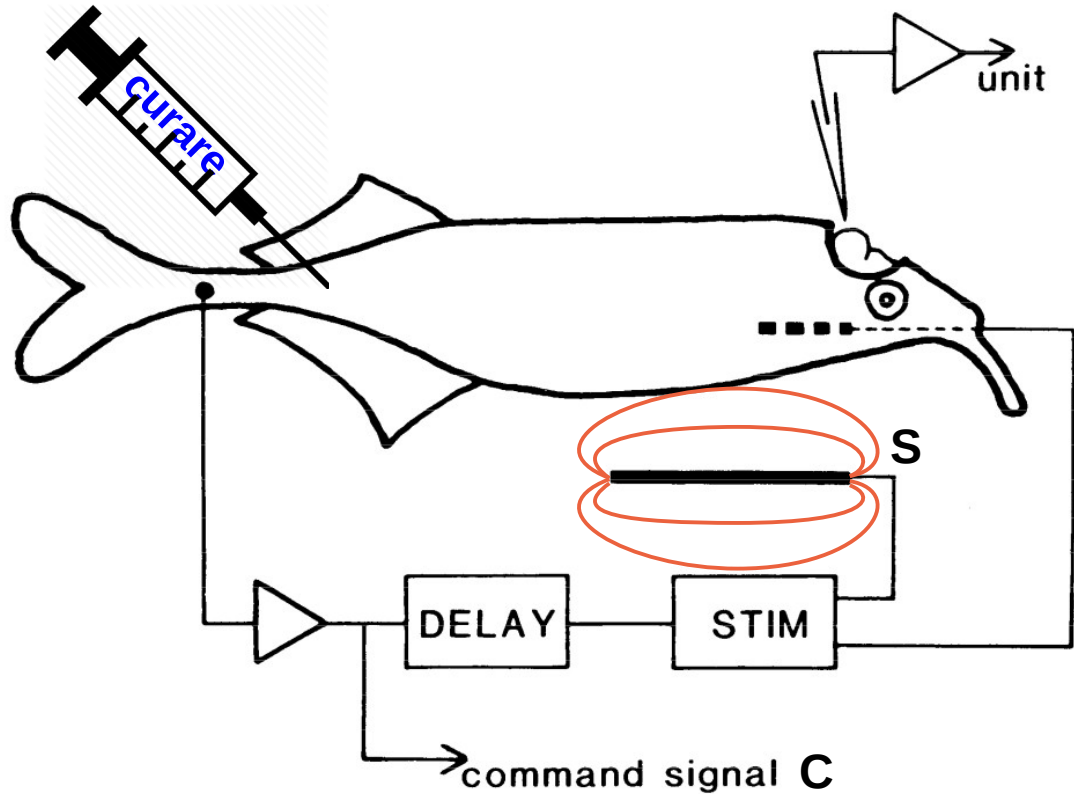

- Fish is curarized : curare blocks effect of motoneurons on electric organ (inhibitor of nAChRs)
→ no discharge
- command signal (**C**) of electromotoneurons recorded (occurrence rate 2-4 /s)
- this signal is used to trigger artificial electric pulses (**S**) in the water (delay ~1.5 ms) mimicking aspects of the EOD
- extracellular recordings from ELL
- fish in wax block perfused by water

Electric fish: effect of Command-Stimulus pairings

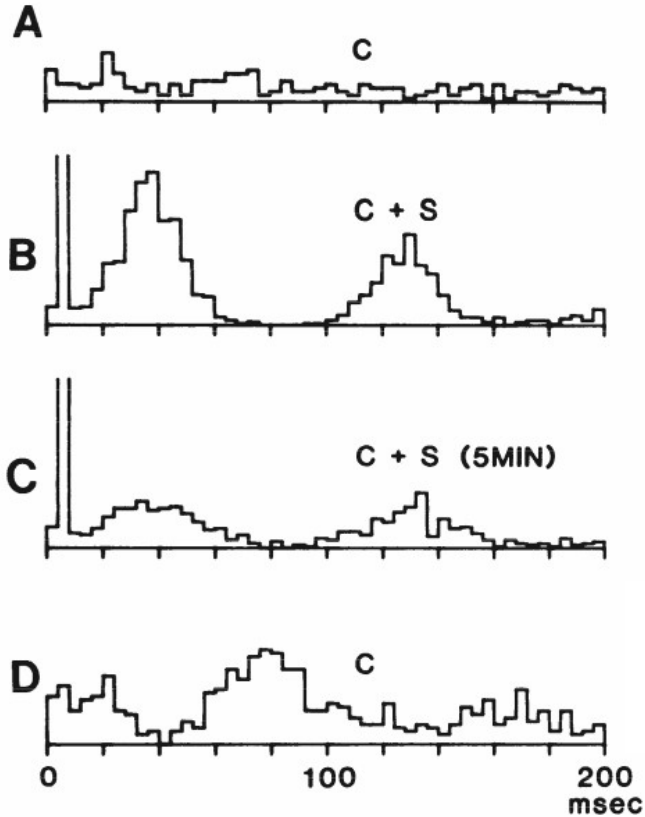

A) Command alone evokes no response

B) Command-stimulus pairing: initial response

C) Command-stimulus pairing: reduced response after 5 min of pairing response

D) Effect of command alone immediately after 7 min of pairing

Electric fish: effect of Command-Stimulus pairings

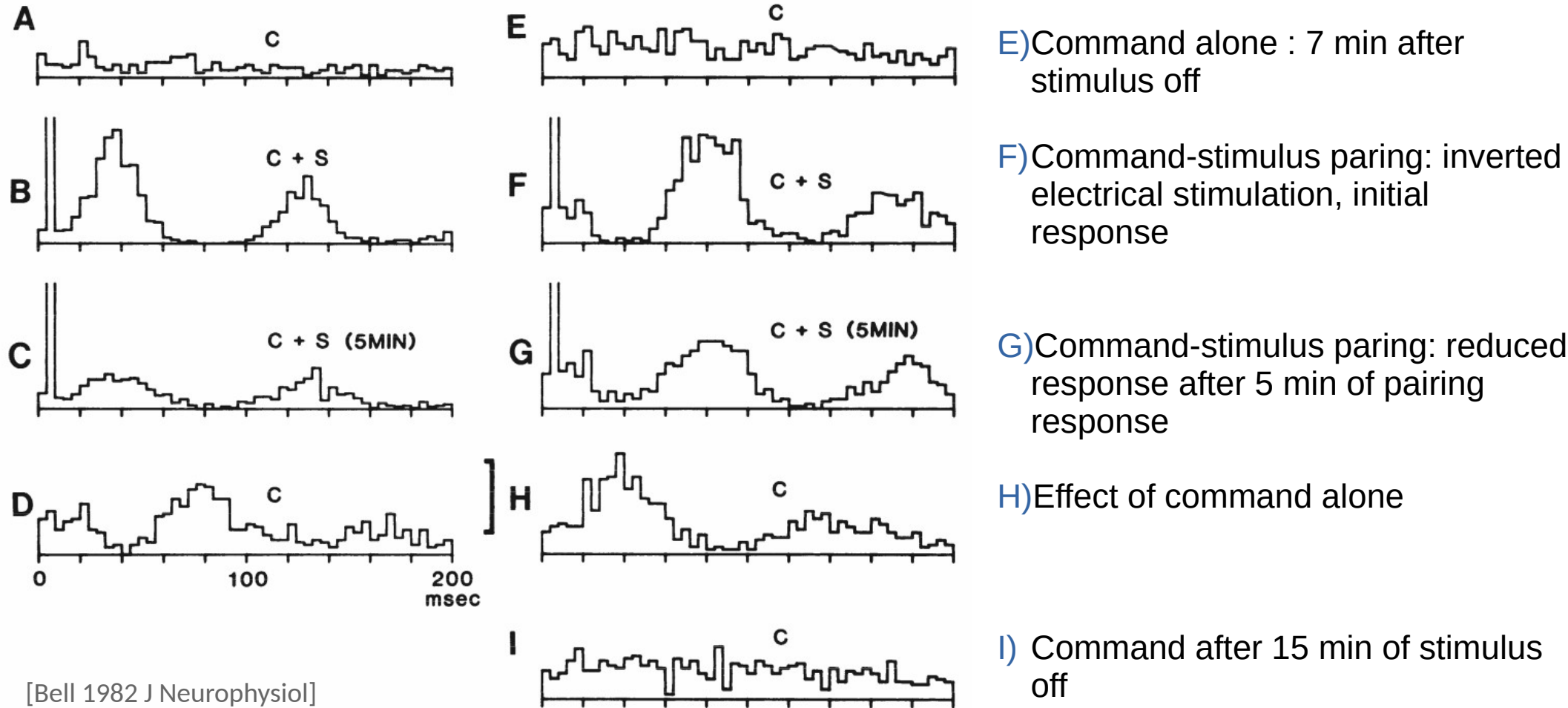

Electric fish experiment: circuit implementation

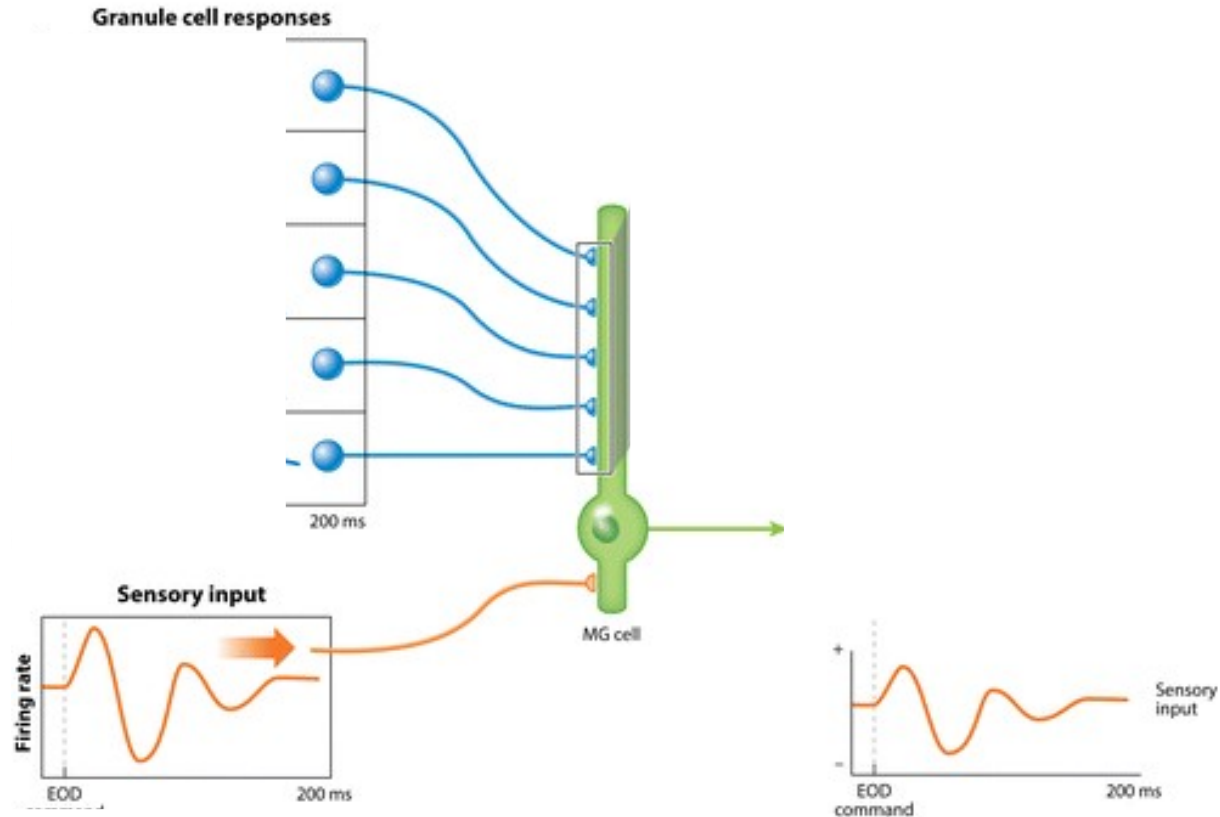

[Sawtell 2017 Annu. Rev. Physiol.]

- Sensory input (reafferrence) should be suppressed
- Desired output : no response to reafferrence
- Animal can use efference copies to create *negative image* of sensory input
- granule cell responses must be varied and prolonged
[Kennedy et al. 2014 Nat Neurosci]
- Requires plastic synapses : anti-hebbian plasticity rule
 - correlations between pre- and postsynaptic activity should decrease synaptic strength

Electric fish experiment: circuit implementation

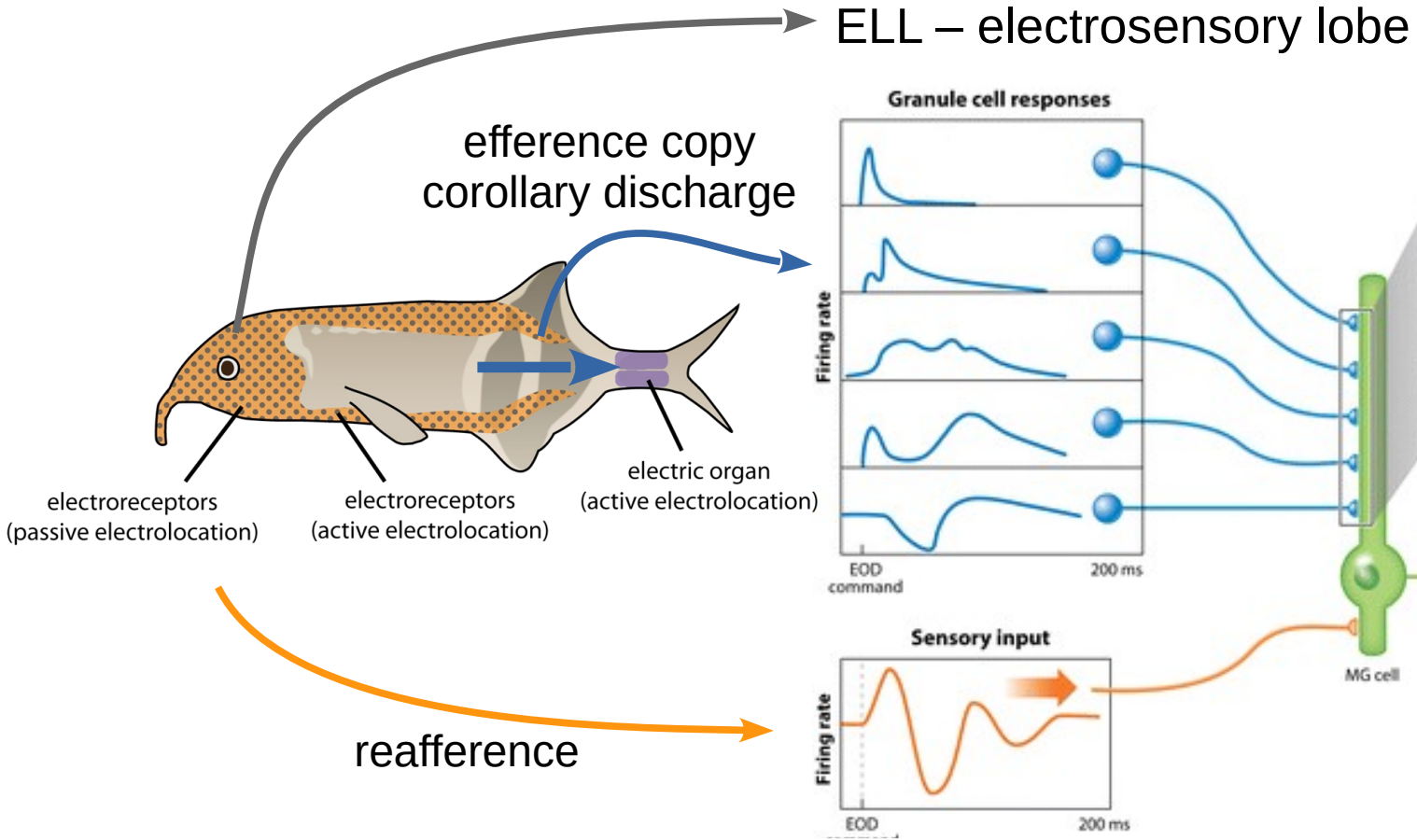

Electric fish experiment: varying stimulus delay

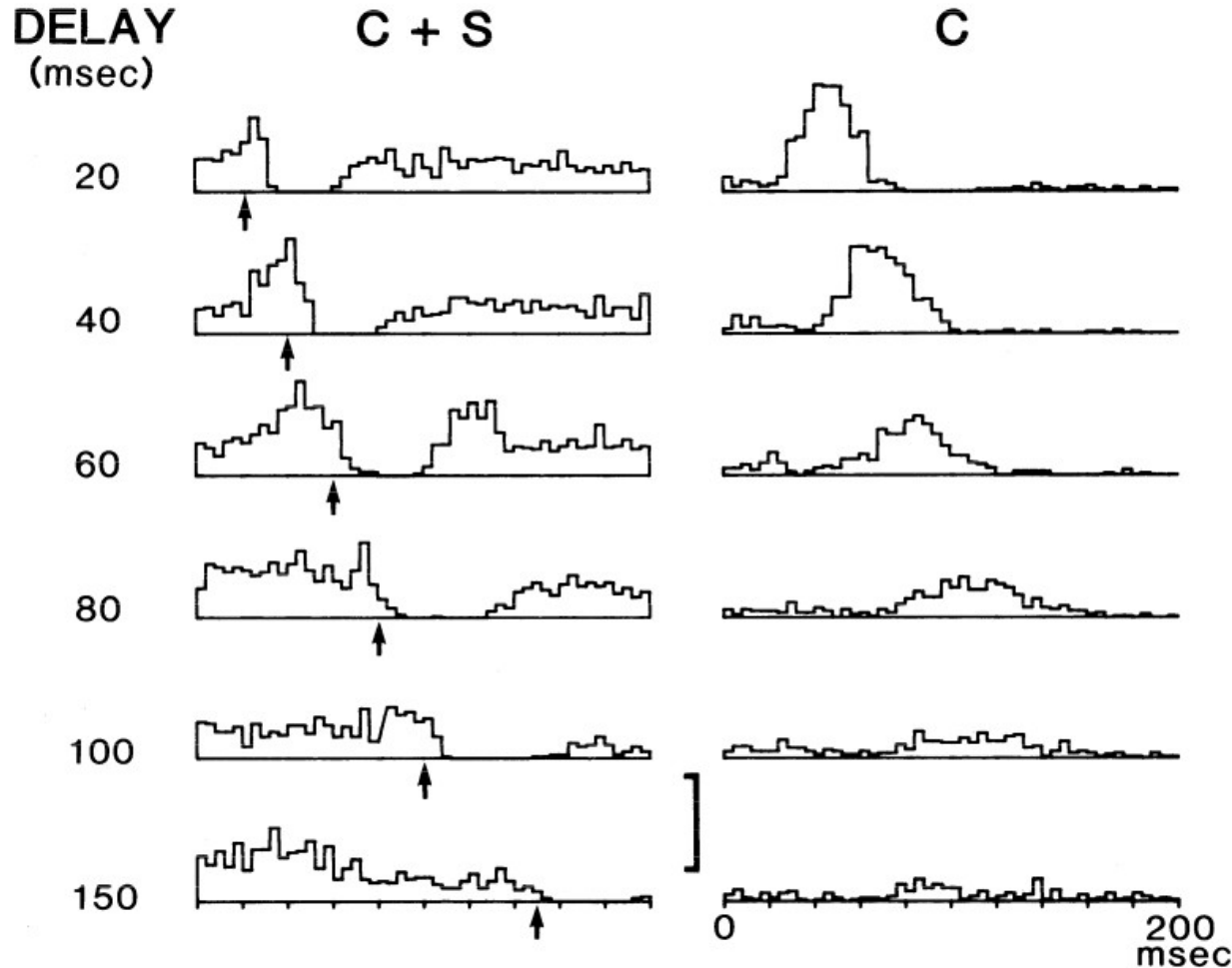

- effect of varying stimulus delay
- **left column :**
command and stimulus were paired for 3-4 min
- **right column :**
effect of the command alone
- in effect, tests the learning curve which implements the formation of the negative image

Formation of negative images in 3 cerebellum-like structures

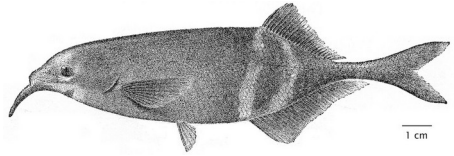

**Mormyrid
ELL**

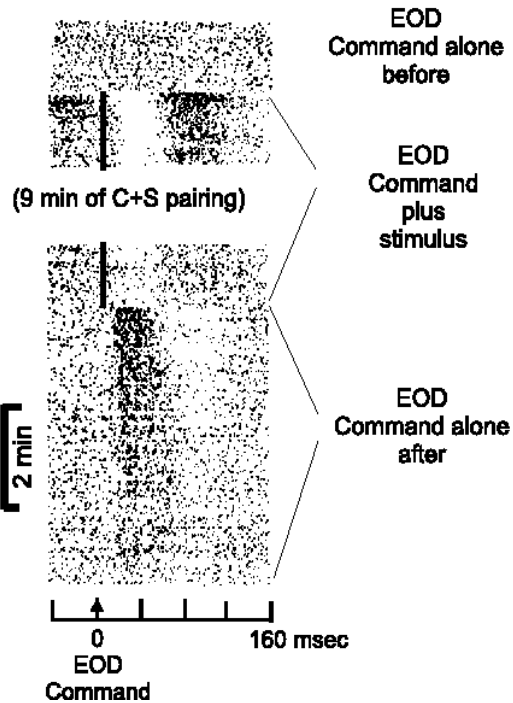

**Gymnotid
ELL**

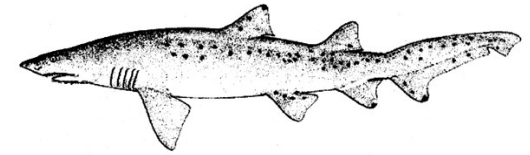
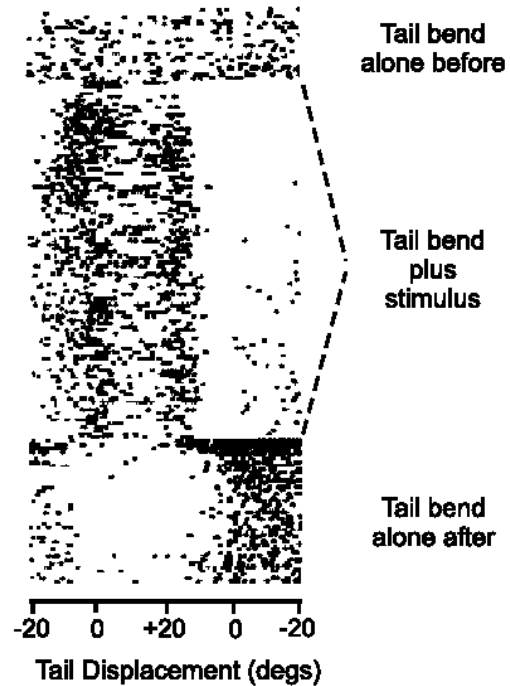

**Elasmobranch
DON**

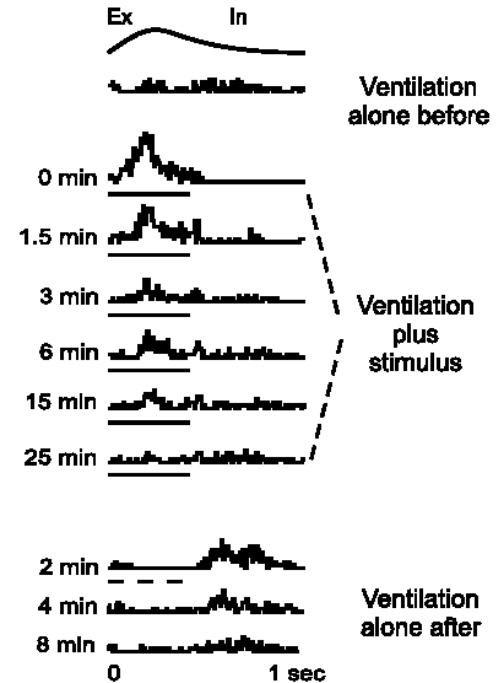

Talk outline

1. Cerebellar disorders

- functions inferred from symptoms
- eye-arm movement coordination with prism glasses

2. Electric fish and prediction of sensory consequences

- anatomy and physiology of the weakly electric fish
- cerebellar circuitry
- cerebellum-like structures
- electric fish and prediction of sensory consequences

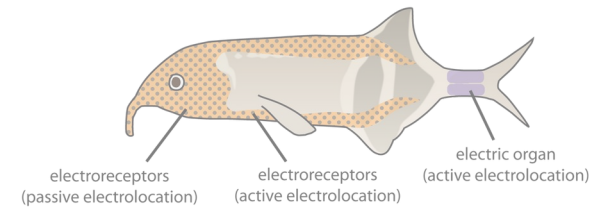

3. Sensory prediction and forward model

- sensory prediction in monkeys
- forward model and the cerebellum

4. Experiments implemented in the lab to unravel cerebellar function

- whisker virtual reality
- learning and adaptation in complex locomotion task

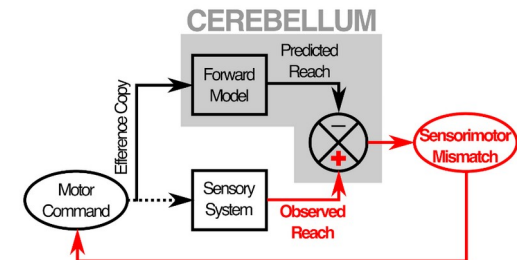

Sensory system activated during movement



Vision

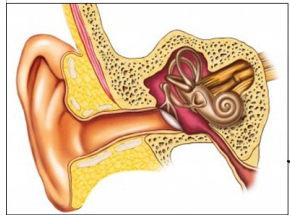

Vestibular System
(inner ear)

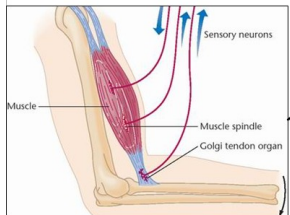

Proprioception
(joint & muscle
movement receptors)

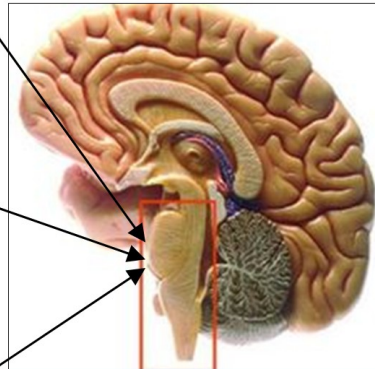

Vision, vestibular system
and proprioceptive inputs
converge onto the
brainstem

- Movement involves visual, vestibular and proprioceptive inputs
 - How can the brain distinguish between consequences of our own self-generated actions (sensory re-afference) and stimulation that is externally produced (sensory ex-afference) ?
- **Hypothesis** : prediction of sensory consequences

[experiment]

Prediction of sensory consequences : two input streams

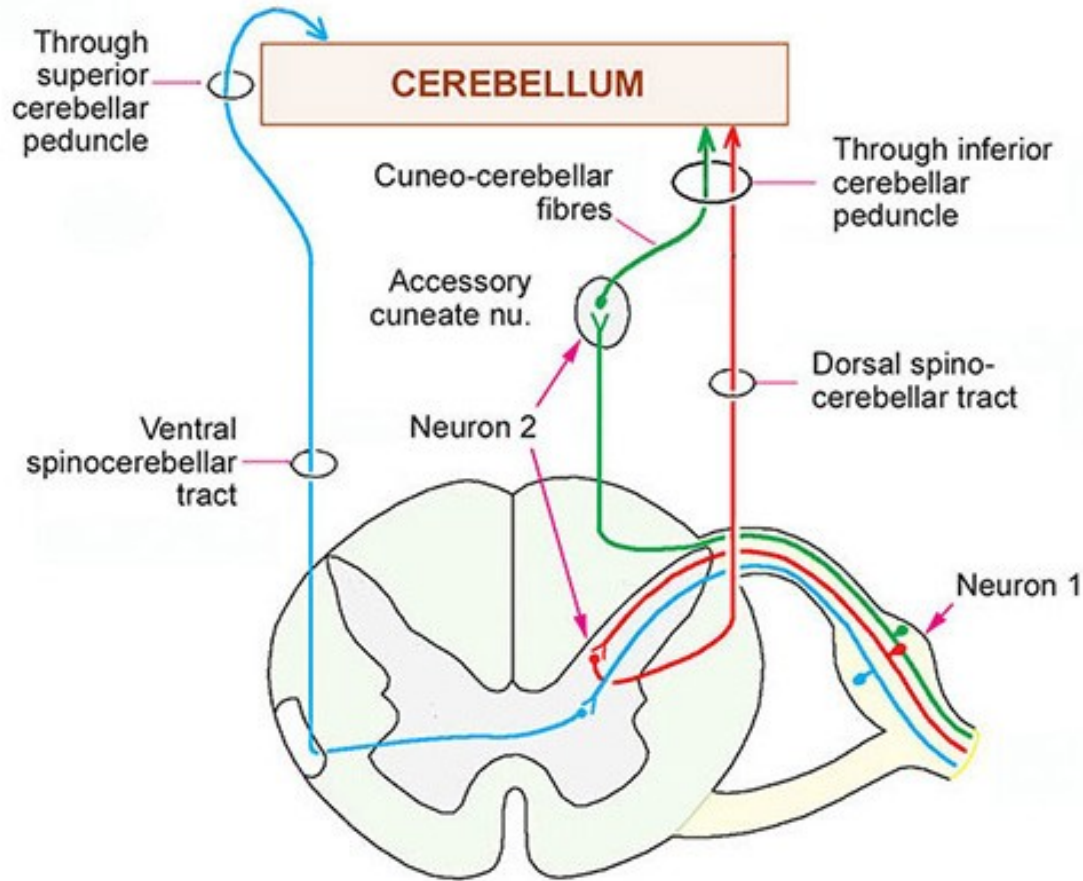

dorsal spino-cerebellar tract

- conveys somatosensory information from muscle and joint receptors
- sensory feedback about consequences of movement (active or passiv)
→ reafference signal

ventral spino-cerebellar tract

- active only during active movement
- cells receive same inputs as spinal motor neurons
→ efference copy/corollary discharge

both provide information from hind limbs

Three subdivisions of the cerebellum : related movements

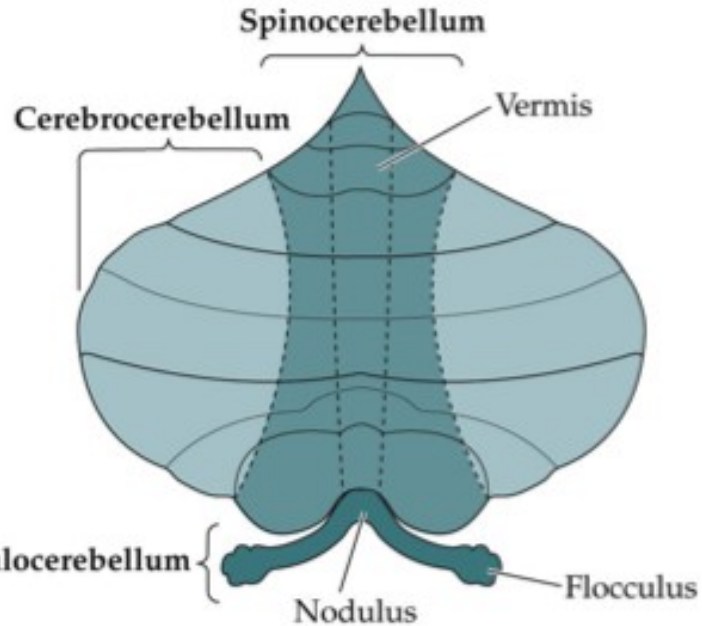

Vestibulocerebellum

- Input: Vestibular, visual path
- Output: Feedback to the vestibular nuclei
- Vestibulo-cerebellar system modulating vestibular influences on posture & eye movement

Spinocerebellum

- Input: Somatosensory, proprioceptive via the spinal cord
- Output: Brain stem reticular, lateral vestibular nuclei
- Spino-cerebellar system regulating muscle tone, posture & locomotion

Cerebrocerebellum

- Input: Cortico-pontine
- Output: Feedback dentate, thalamus, motor and premotor cortex
- Cerebro-cerebellar system regulating skilled movement.

Three subdivisions and their output pathways

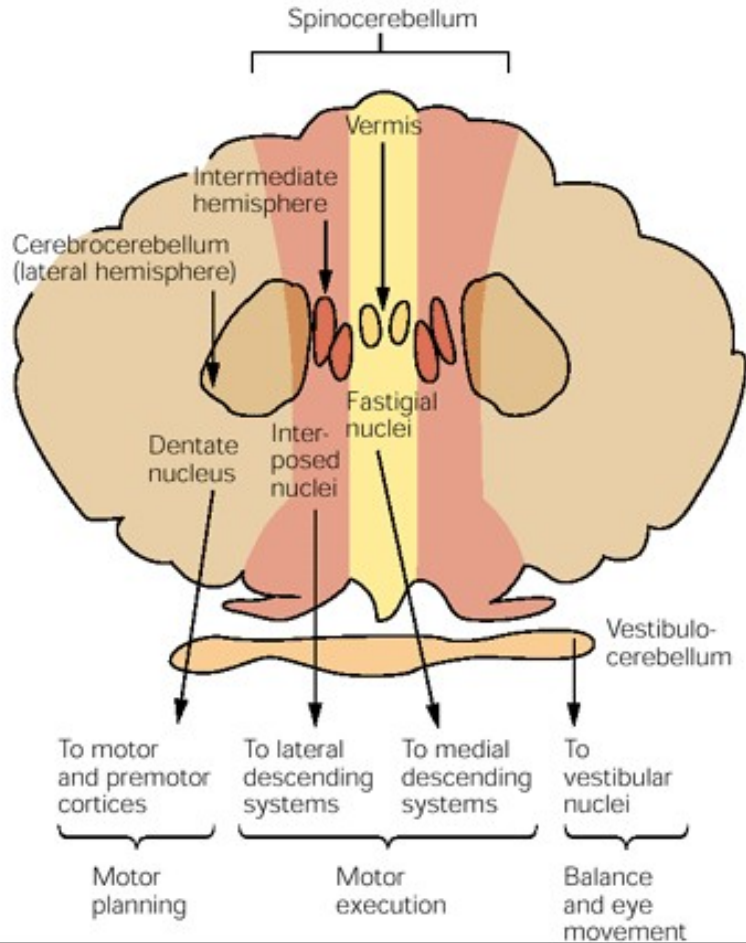

Vestibulocerebellum

Spinocerebellum

Cerebrocerebellum

Monkey experiment: sensory processing in cerebellum

Passive

head motion

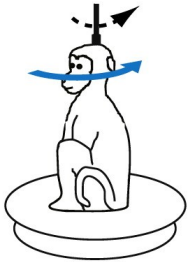

Active

head motion

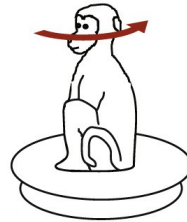

behavioral paradigm

- passive versus active movement in monkeys
- passive movement : unexpected vestibular stimulation (exafference)
- active movement : voluntary action evoked vestibular input (vestibular reafference)

Cells responsive to passive but not active movement

unimodal cell

Passive
head motion

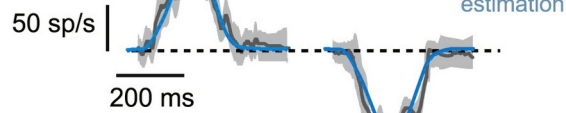
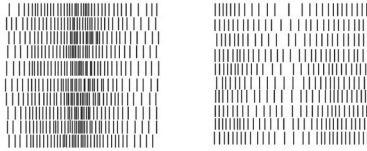
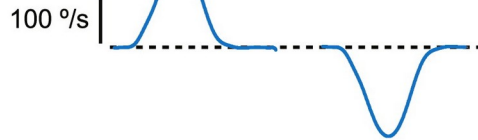

- cells (unimodal and bimodal) were strongly modulated during passive head and body motion

Cells responsive to passive but not active movement

unimodal cell

Passive

head motion

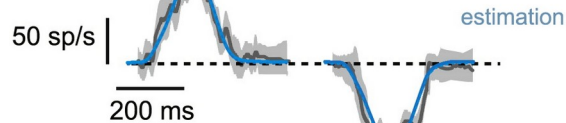
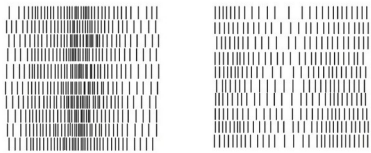
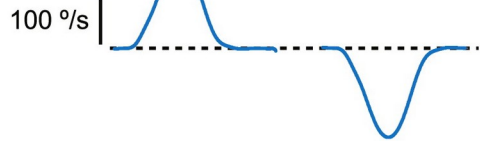

Active

head motion

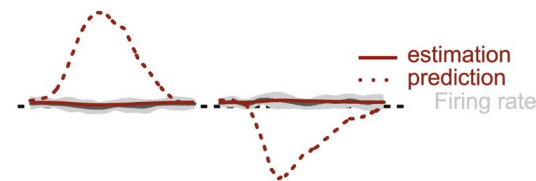
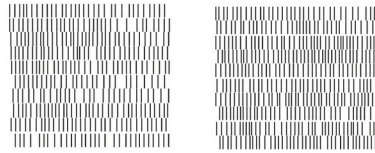
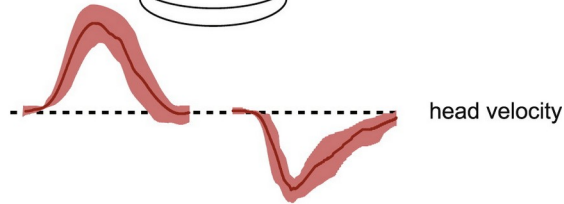

- cells (unimodal and bimodal) were strongly modulated during *passive* head and body motion
- same cells were unresponsive to same motion when voluntarily produced

Neurons selectively respond to passive movement

unimodal cell

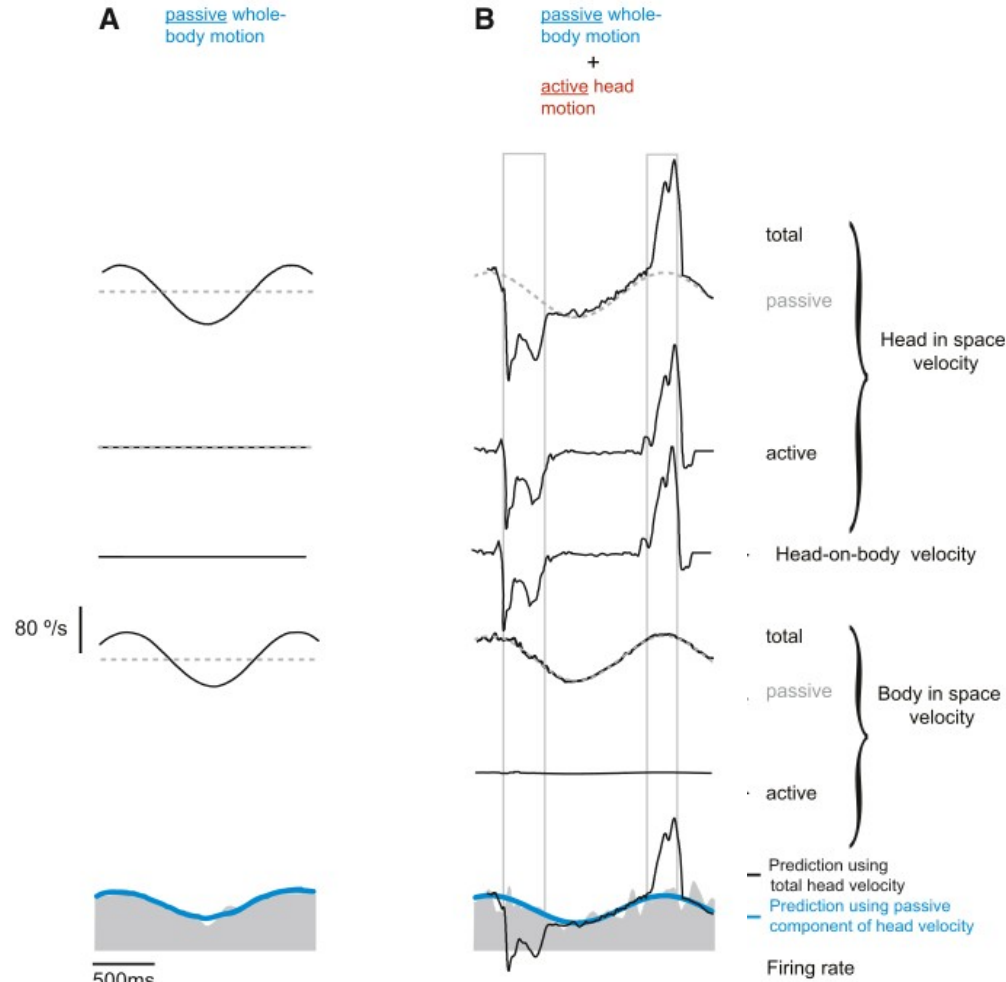

- unimodal neurons respond selectively to passively applied stimulation
- in combined movements – passive and active – the neuron robustly encode head motion due to passively applied rotation

Experimental evidence in mammals for negative image

unimodal cell

Passive

head motion

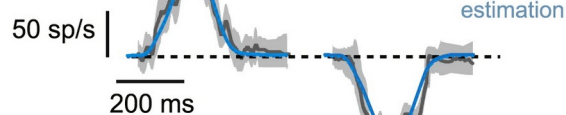
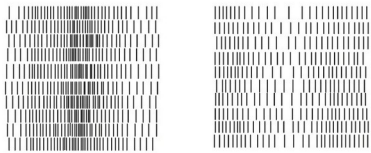
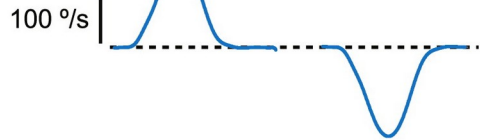
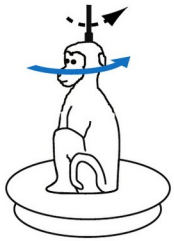

Active

head motion

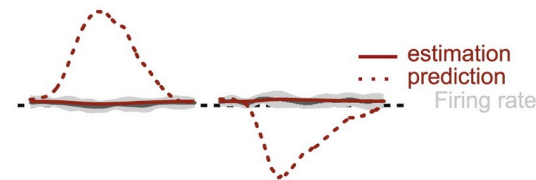
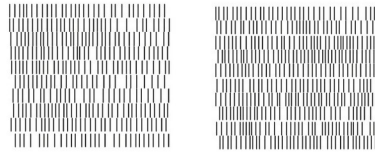
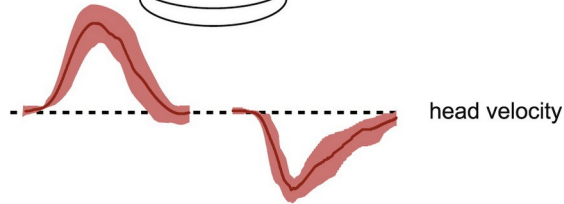
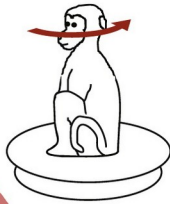

- cells in fastigial nucleus encode unexpected movements of head and body
- supports the notion that the cerebellum computes a prediction of sensory consequences which is compared to the sensory consequences of the actual movement

Suggestion : Cerebellum implements a forward model

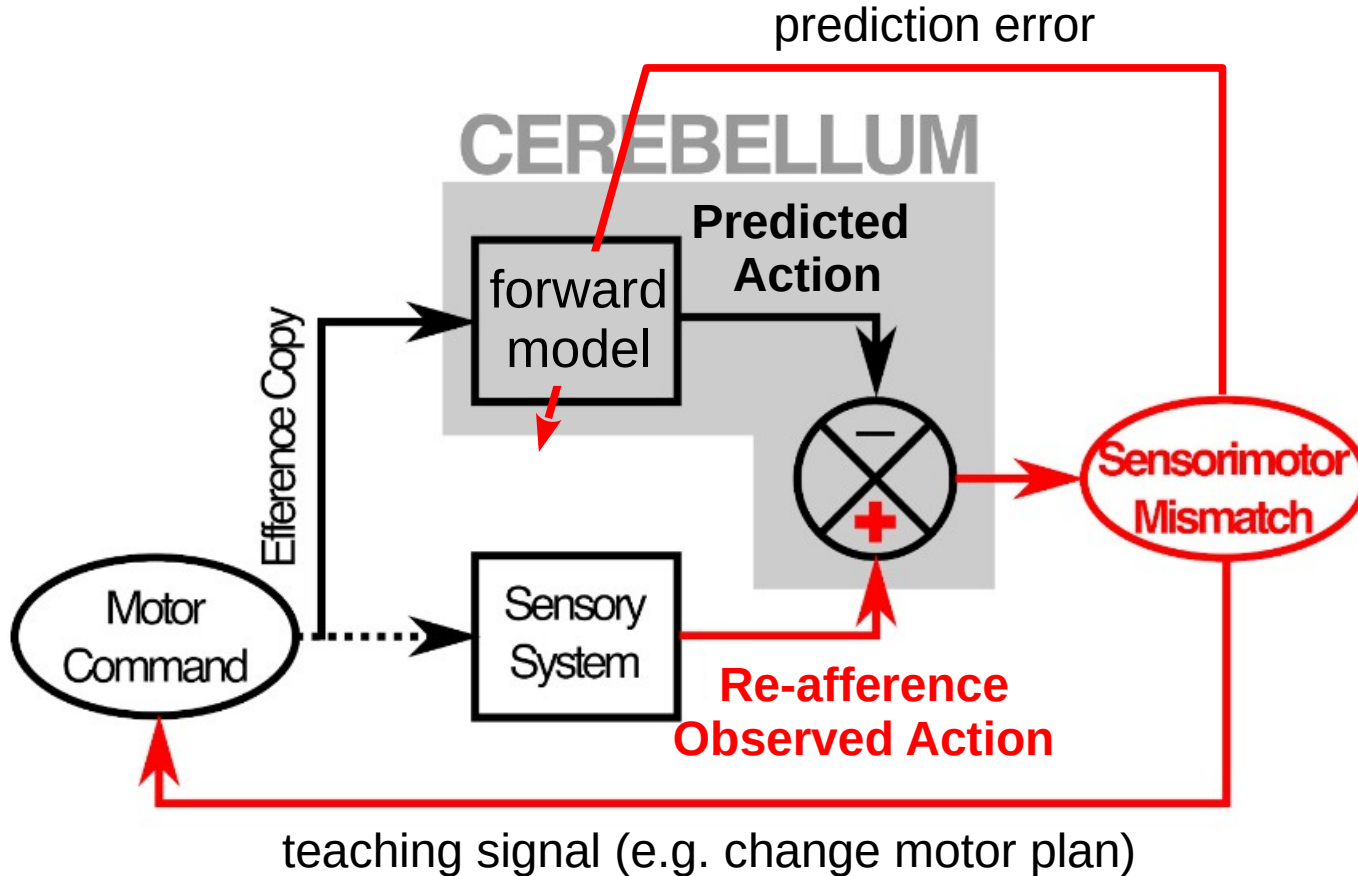

- cerebellum computes a prediction of sensory consequences which is compared to the sensory consequences of the actual movement
- **match**: the sensory afference should be interpreted as internally caused
- **mismatch**: the difference between the actual and the predicted input should be interpreted as externally caused

Suggestion : Cerebellum implements a forward model

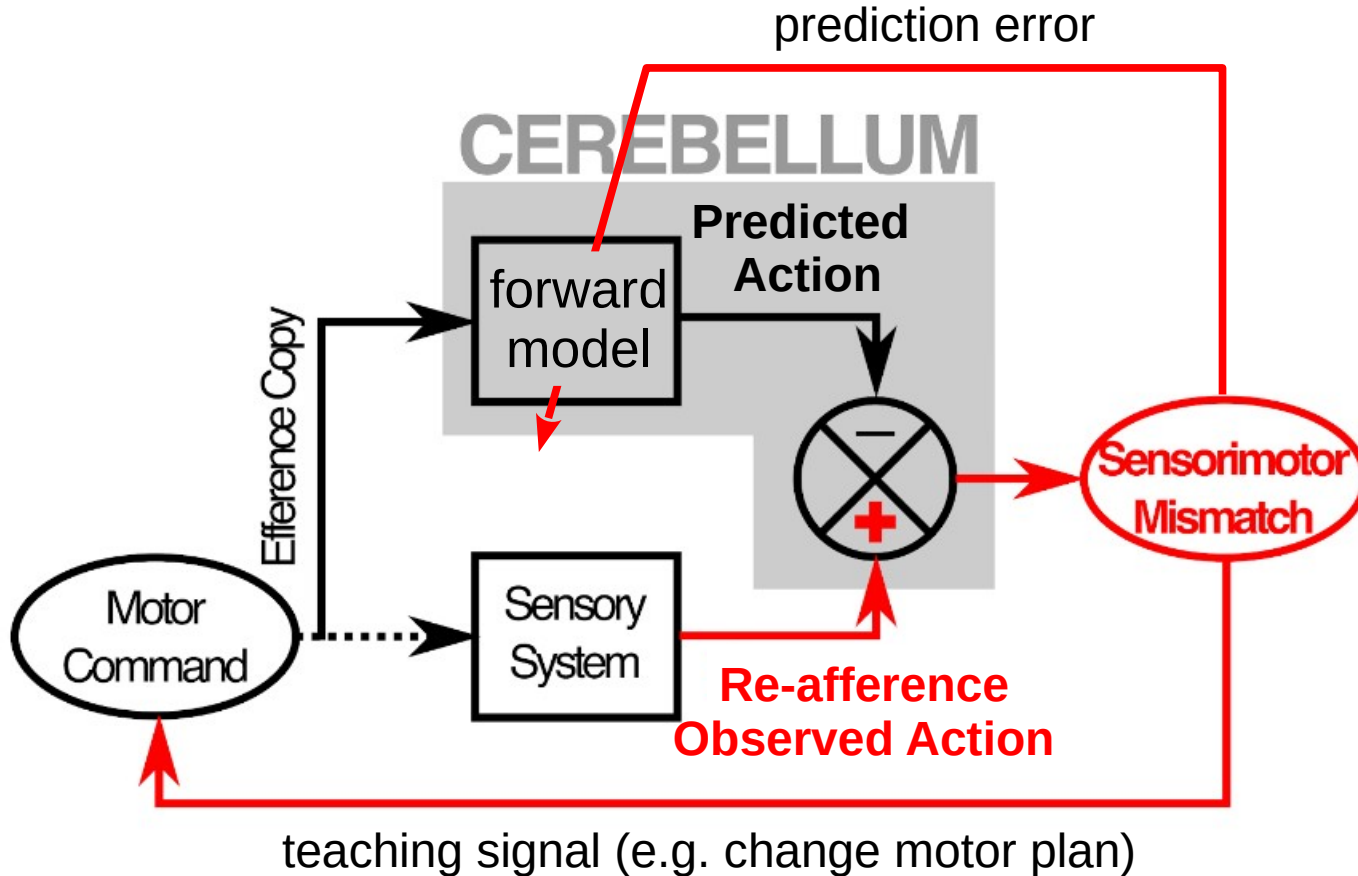

- cerebellum computes a prediction of sensory consequences which is compared to the sensory consequences of the actual movement

usefulness

- comparison can be used to compute error used as teaching signal to update the motor program
- computation of sensory prediction errors enables brain to distinguish between self-generated and externally produced actions

Forward model requires an adaptive filter

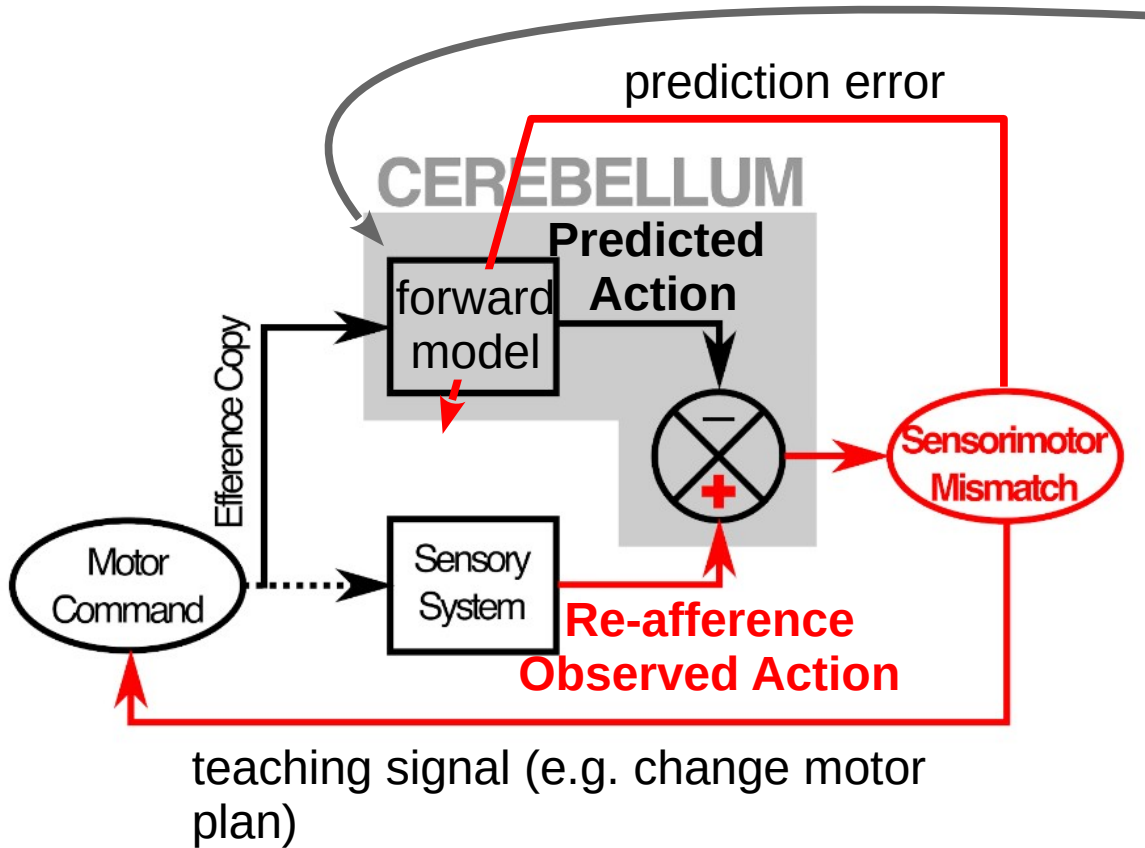

calculation of prediction based on adaptive filter:

- input signals consists of a large number of components
- combining these components by weighting them individually and then summing to produce the filter output
- adjustment of the weights by a teaching signal

Forward model requirements

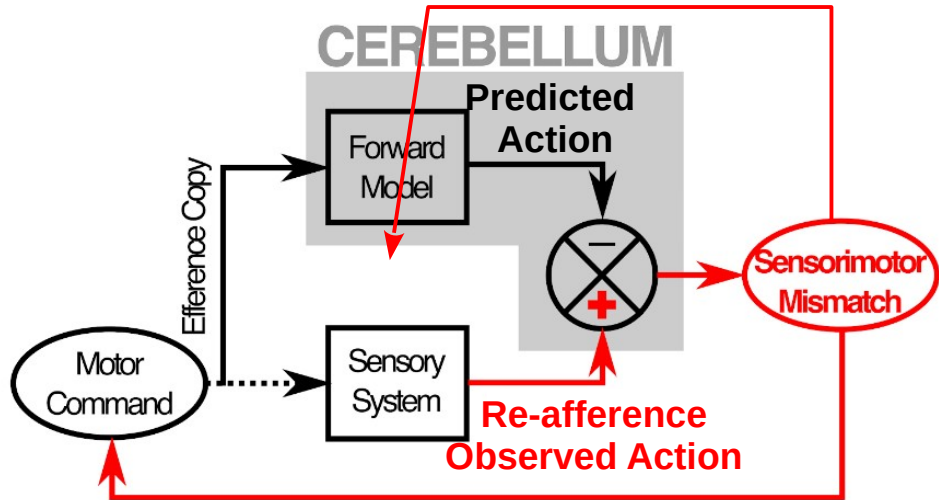

- two distinct input streams :
 - mossy and climbing fibers
- adaptive filter requires to adjust prediction during learning, or due to changes in environment :
 - parallel fiber → Purkinje cell synapse
 - mossy fiber → deep cerebellar nuclei synapse

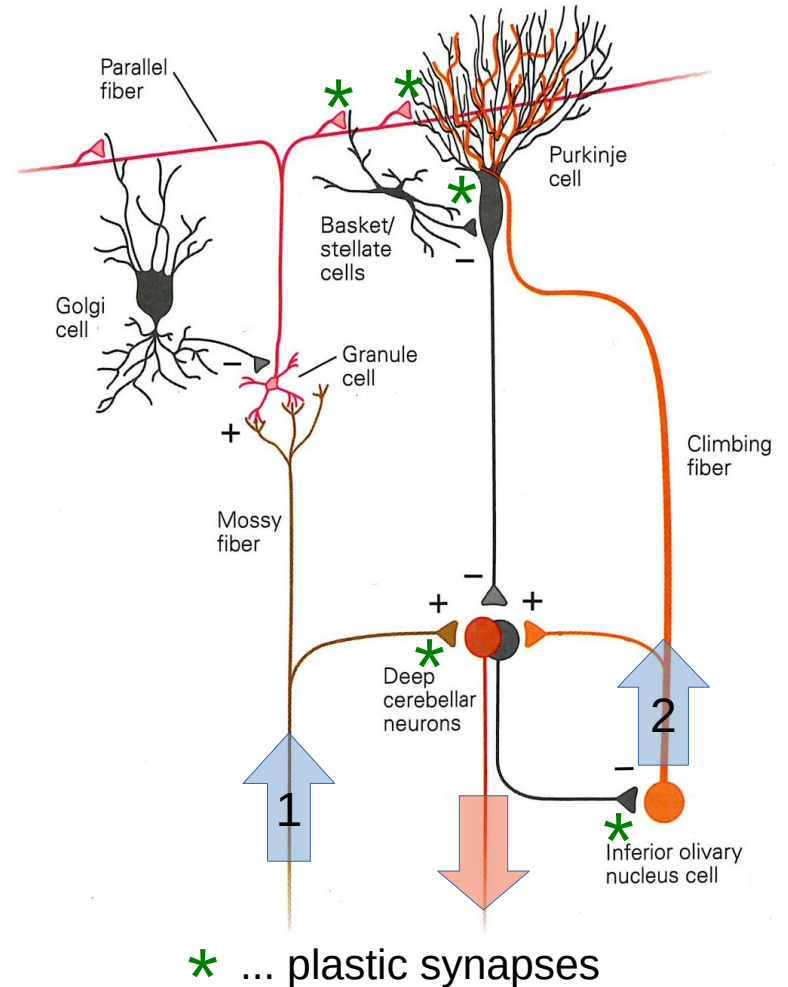

Talk outline

1. Cerebellar disorders

- functions inferred from symptoms
- eye-arm movement coordination with prism glasses

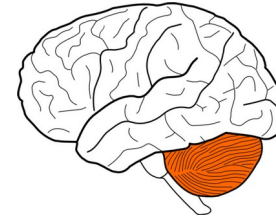

2. Electric fish and prediction of sensory consequences

- anatomy and physiology of the weakly electric fish
- cerebellar circuitry
- cerebellum-like structures
- electric fish and prediction of sensory consequences

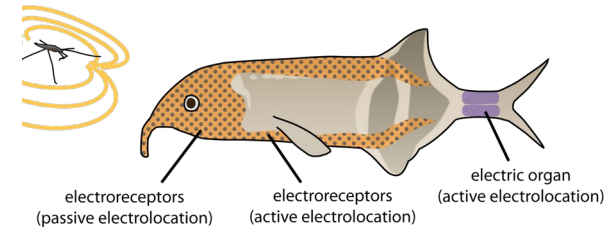

3. Movement prediction and forward model

- sensory prediction in monkeys
- forward model and the cerebellum

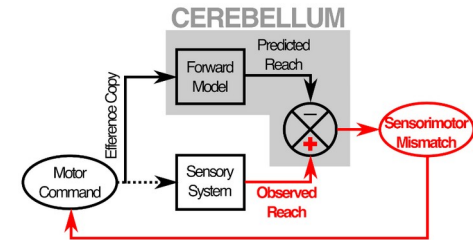

4. Experiments implemented in the lab to unravel cerebellar function

- whisker virtual reality
- learning and adaptation in complex locomotion task

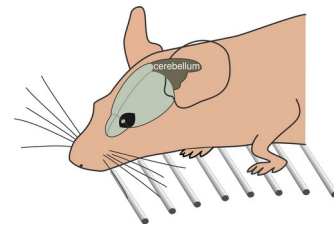

1. Project : Whisker virtual reality – sensorimotor mismatch

Aim : Study effect of sensorimotor mismatch during locomotion in rodent cerebellum.

Method : Reproduce mouse running through tunnel

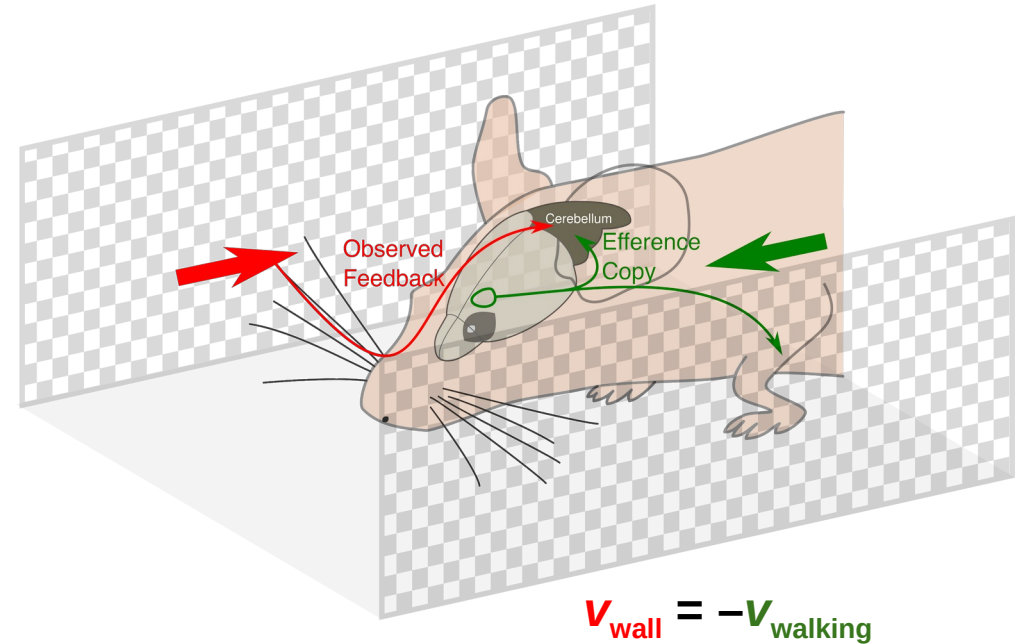

[Brandon Stell]

Locomotion with side-walls generates sensory feedback

Sensorimotor mismatch can be introduced by altering observed whisker feedback.

Are the different signals present in the cerebellum and where is the possible comparison between expected and received sensory feedback computed ?

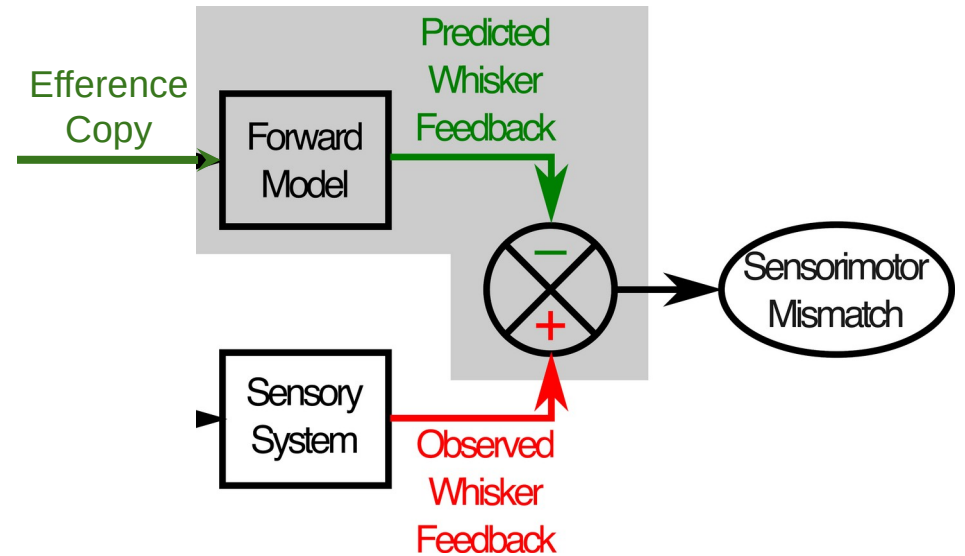
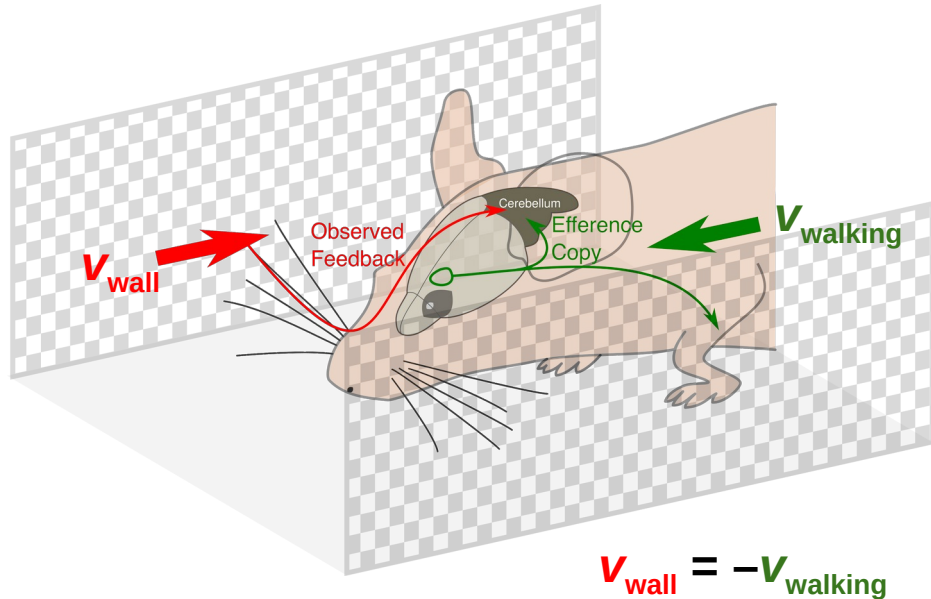

Whisker virtual reality

The virtual reality setting allows to externally control the perceived whisker feedback

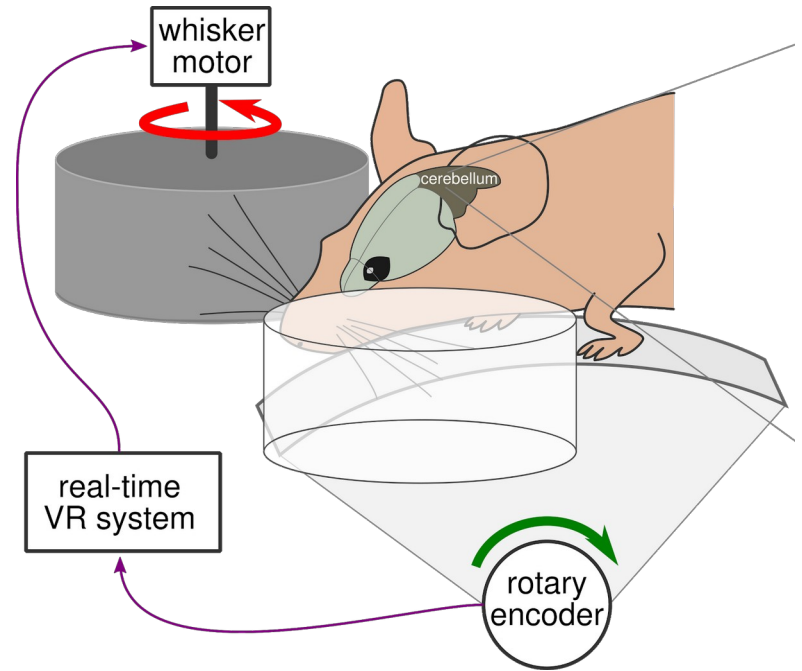
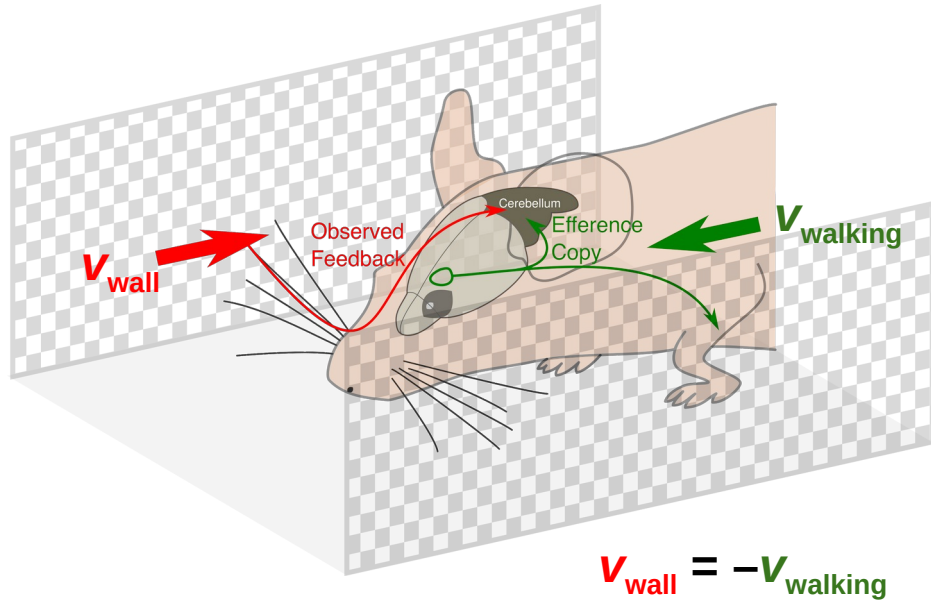

[video]

Whisker virtual reality

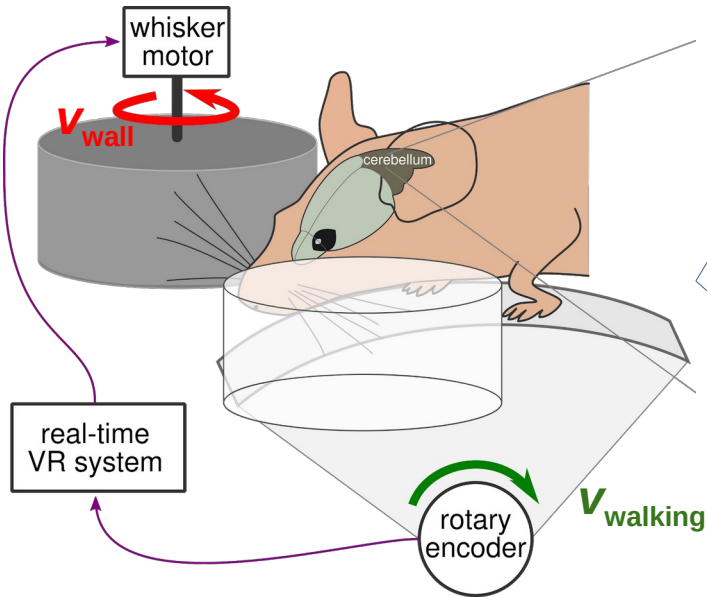

closed loop configuration :

- walls move at the walking speed

$$v_{\text{wall}} = -v_{\text{walking}}$$

- provided tactile feedback matches expected feedback from locomotion

open loop configuration :

- walls move at a different speed than the walking speed

$$v_{\text{wall}} \neq -v_{\text{walking}}$$

- sensorimotor mismatch : tactile feedback speed does not correspond to locomotion speed

Introducing transient sensorimotor mismatch

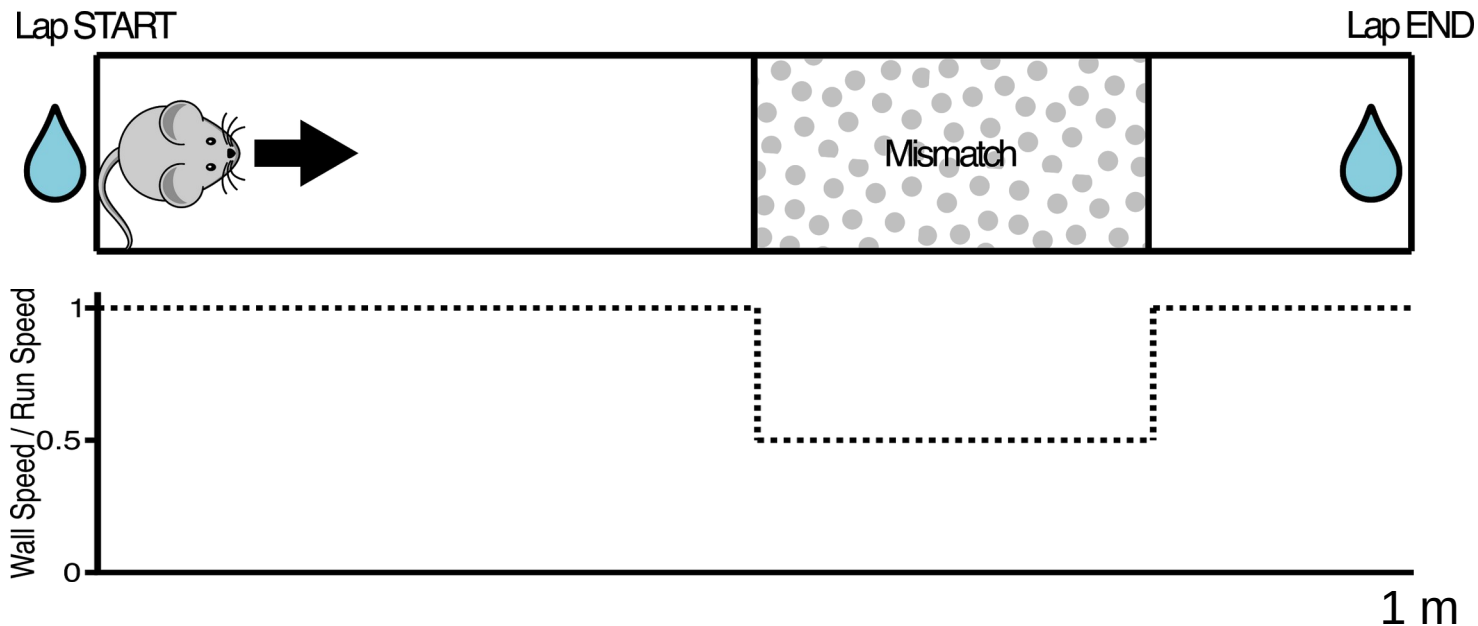

- mice are motivated to run 1 m long laps through water rewards
- **Our hypothesis** : animals will accelerate in response to wall speed decrease

Mice run readily 1m laps for water reward

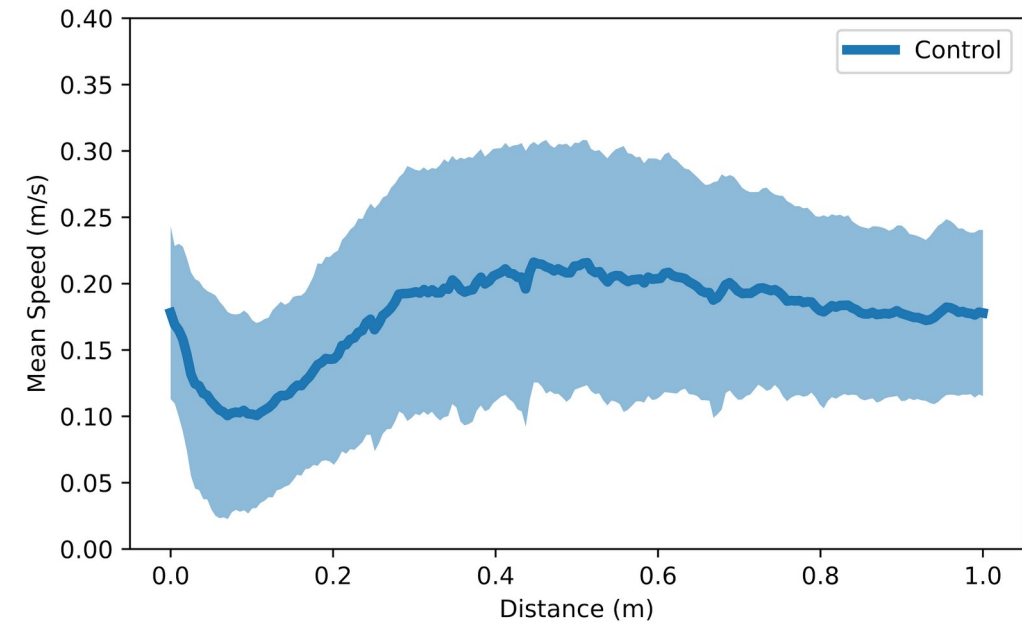
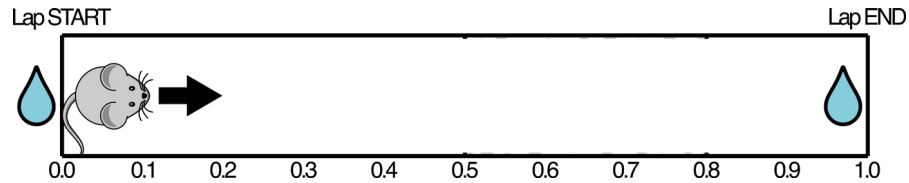

Mean speed over :
280 **control** laps

Mice run readily 1m laps for water reward

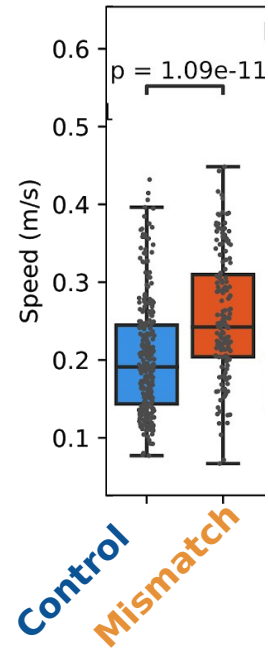
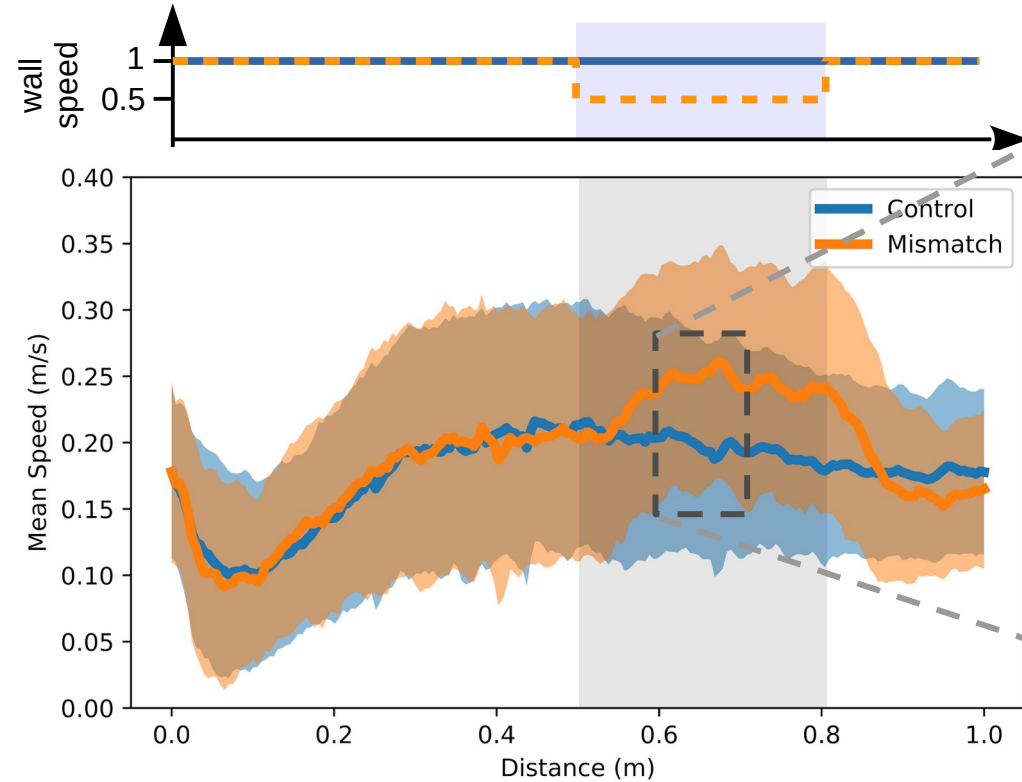
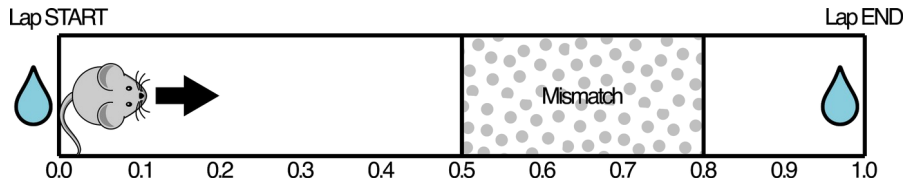

Mean speed over :
280 **control** laps
165 **mismatch** laps

Two-photon calcium imaging from Purkinje cells

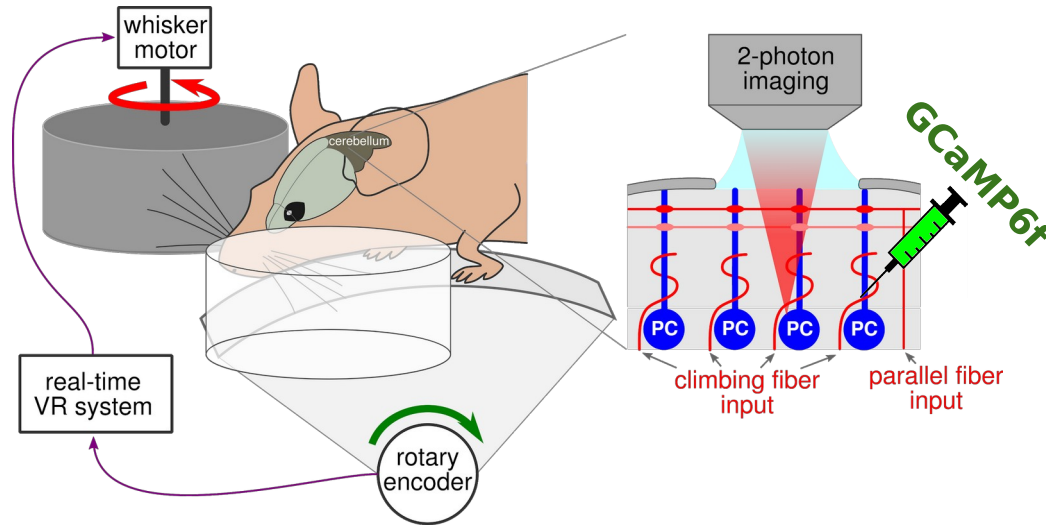

Questions :

1. Do we find neural correlates for efferent copy and re-afference ?
2. At which stage could a comparison between the two take place ?
3. What is the cellular signature of the sensorimotor mismatch in the cerebellar cortex ?

2. Project : Cerebellum and locomotion

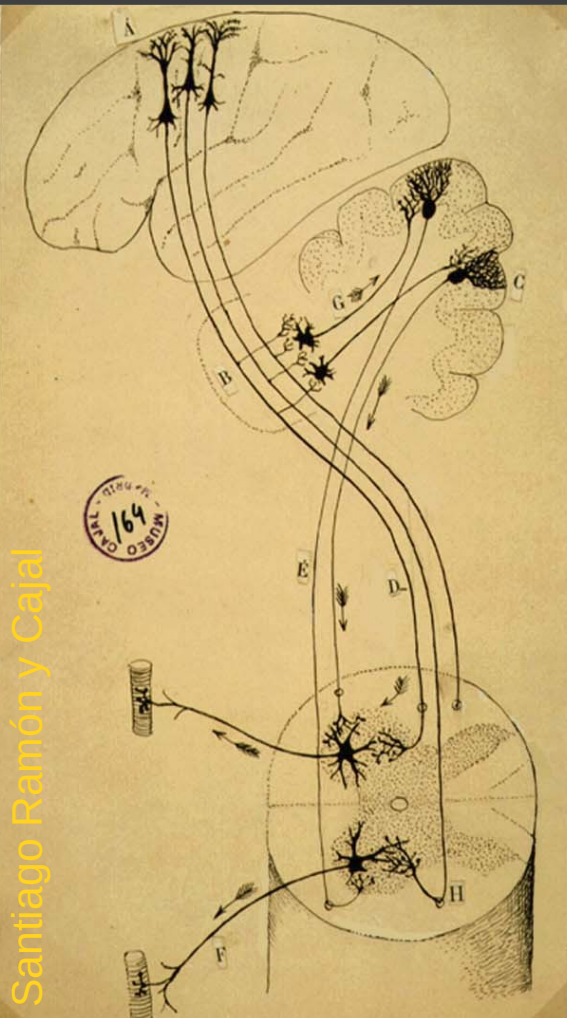

Cerebellum ensures that movements are well timed and highly coordinated.

During walking :

- Cerebellum is essential for on-the-fly corrections of posture and gait
- cerebellar dysfunction leads to balance problems and walking abnormalities

Questions :

- What are the cellular underpinnings of motor coordination ?
- What is the influence of activity in the cerebellar cortex on motor behavior ?

Erasmus lader

Erasmus Ladder™ (Noldus)

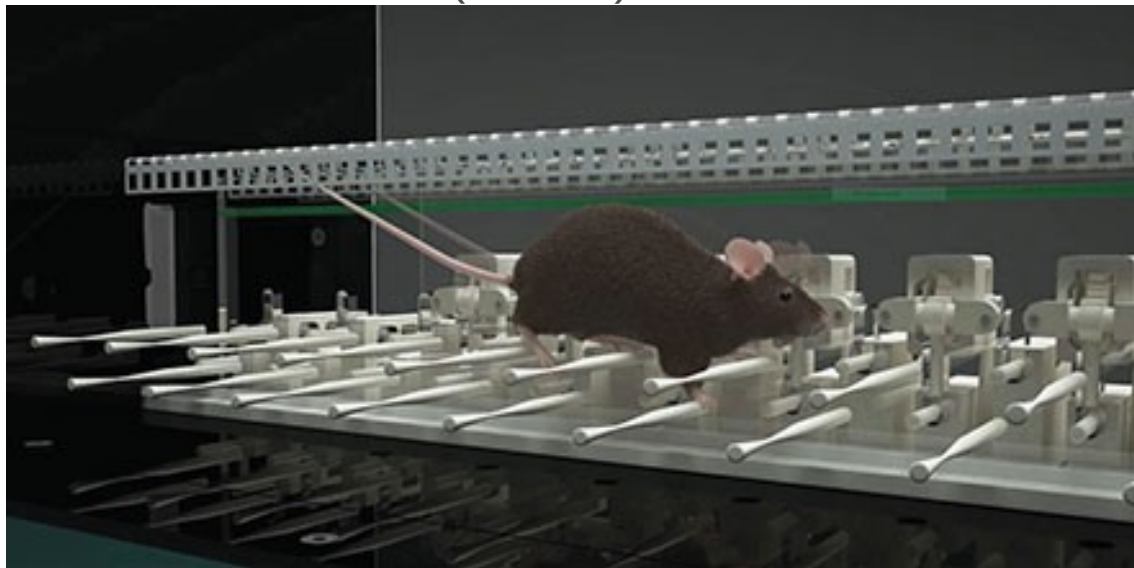

Erasmus ladder: behavioral paradigm

Non-perturbed Sessions

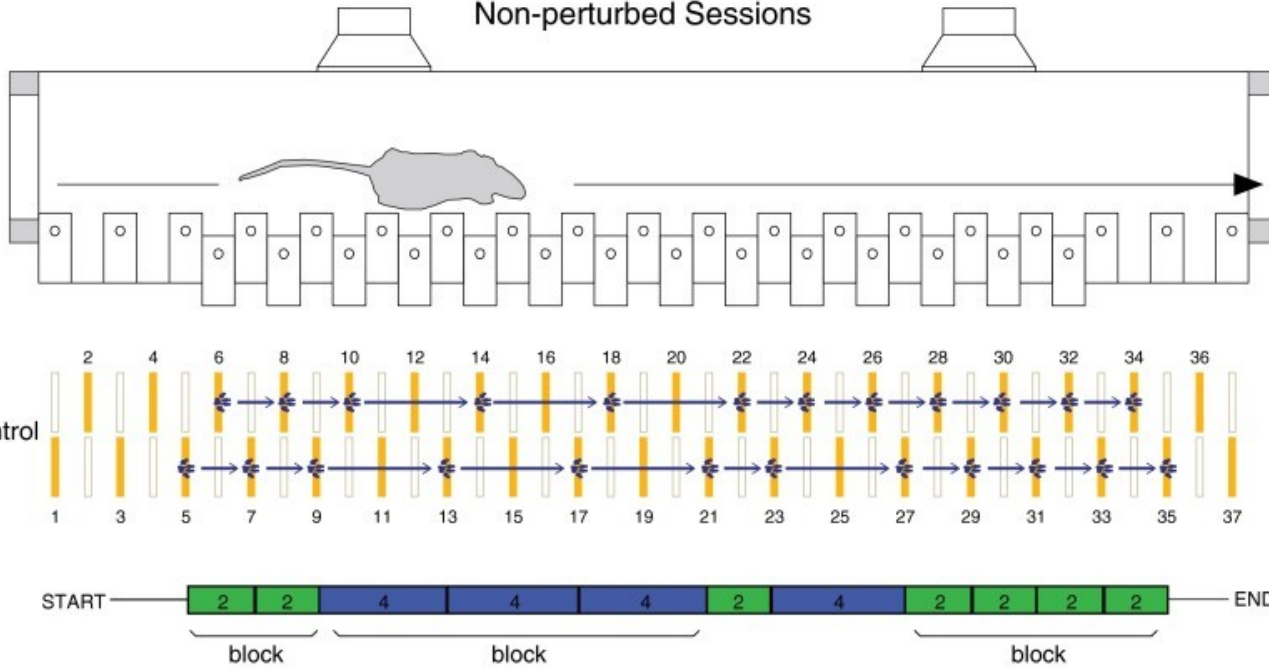

baseline locomotion

- animal is made to cross horizontal ladder
- pressure sensors on rungs/bars allows to extract stepping pattern

Erasmus lader: behavioral paradigm

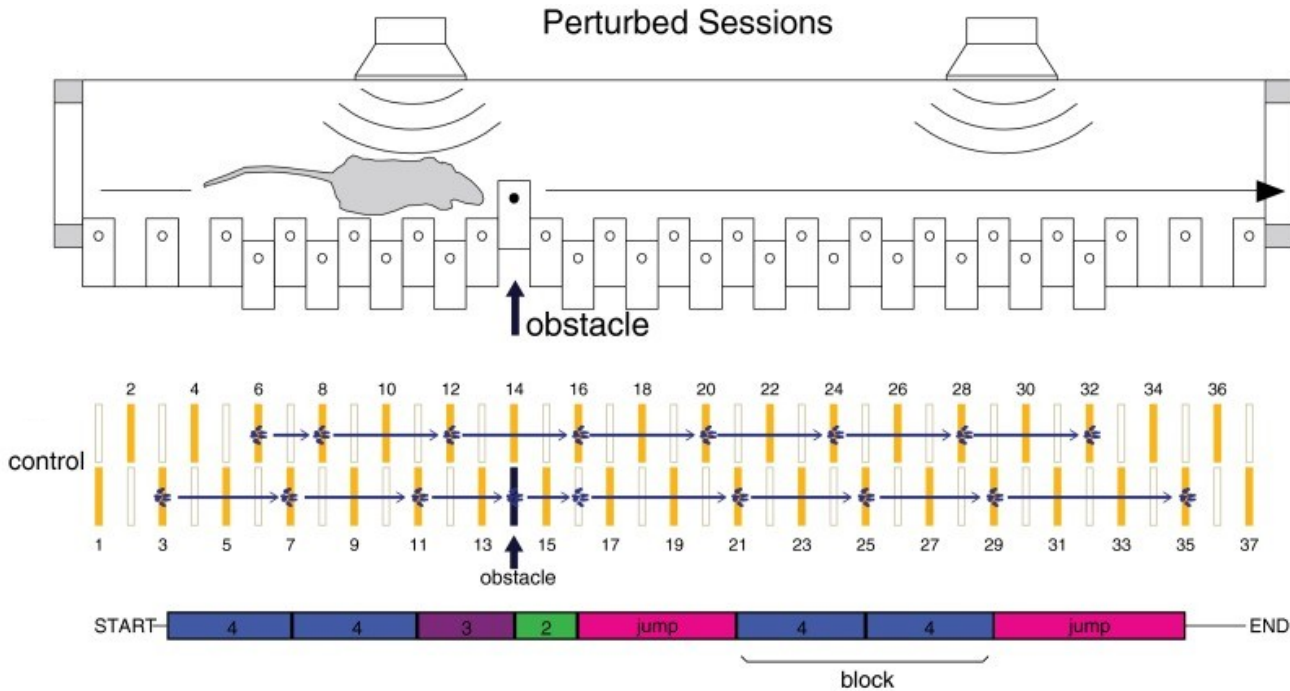

locomotion adaptation

- mice are challenged with the introduction of an obstacle
- obstacle was introduced by elevating one of the rungs, was preceded by a tone 200 ms prior to occurrence

Erasmus ladder: cerebellar inhibition knock-mice

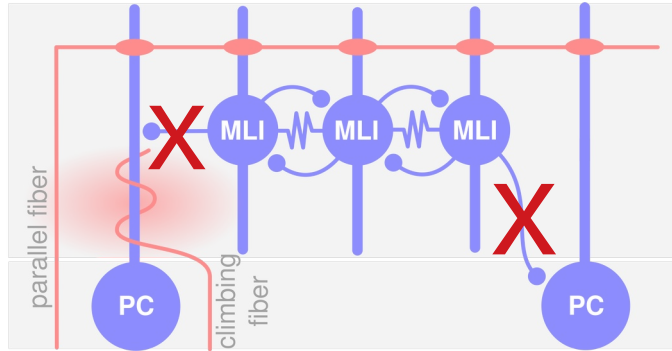

Regular steps (%)

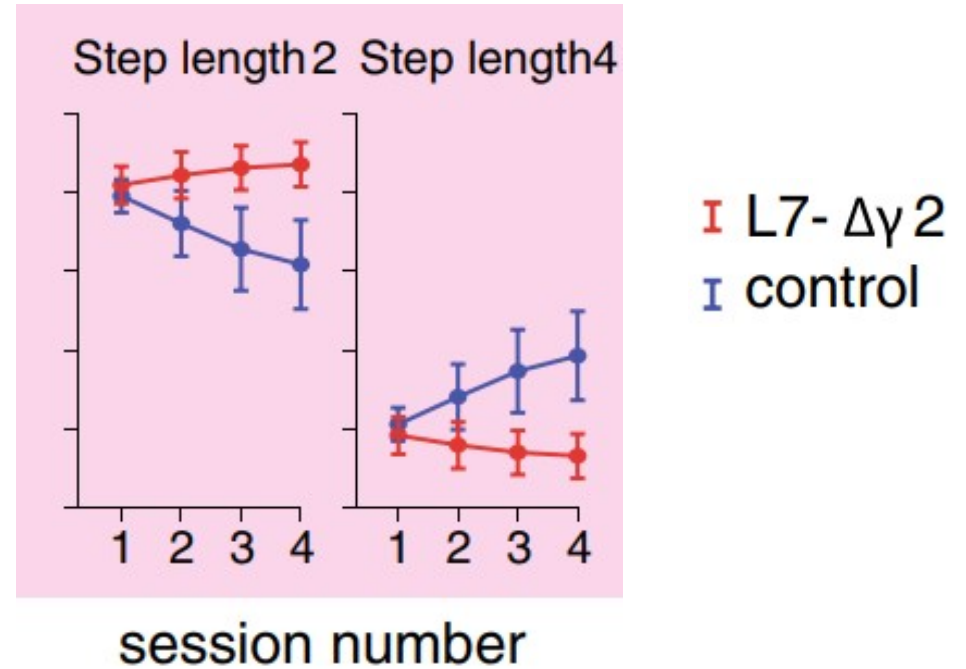

- locomotion learning is impaired in Purkinje cell inhibition knock-out mice (L7- $\Delta\gamma 2$)

[Veloz *et al.* Brain Struct Funct 2015]

Erasmus ladder: cerebellar inhibition knock-mice

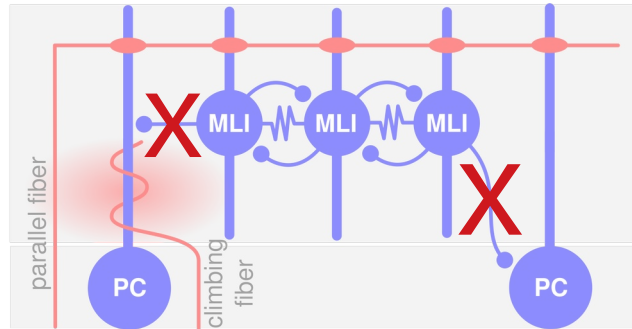

I L7- $\Delta\gamma 2$
I control

Regular steps (%)

unperturbed sessions

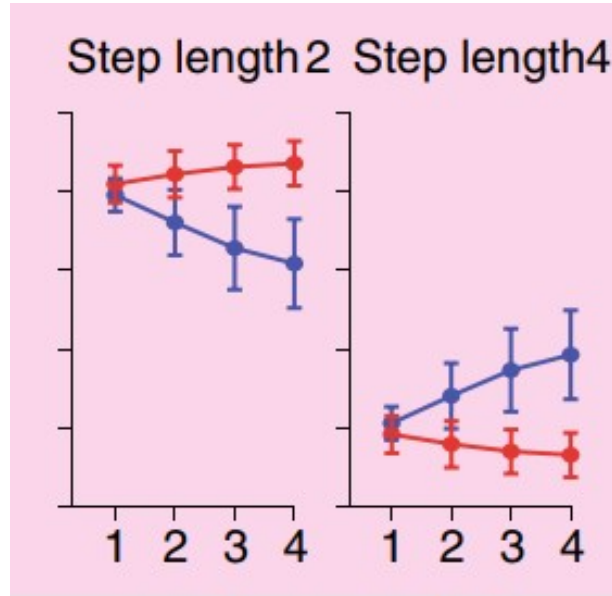

session number

perturbed sessions

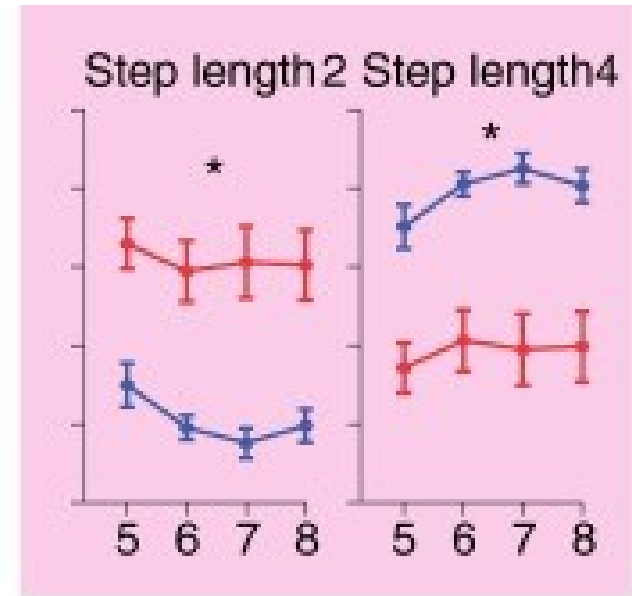

session number

- locomotion learning and adaptation is impaired in Purkinje cell inhibition knock-out mice (L7- $\Delta\gamma 2$)

[Veloz *et al.* Brain Struct Funct 2015]

Task to study coordination on cellular level

Erasmus Ladder

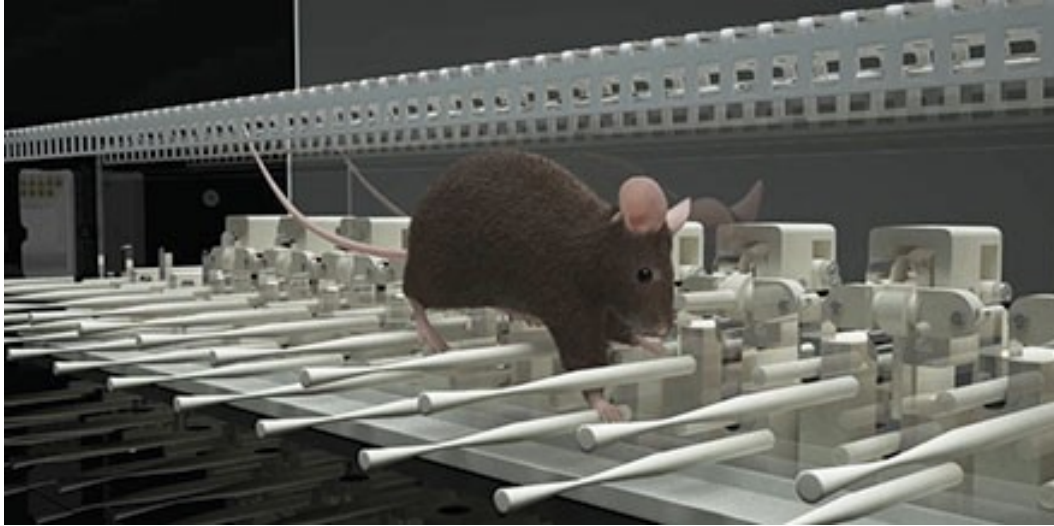

[Veloz et al. *Brain Struct Funct* 2015]

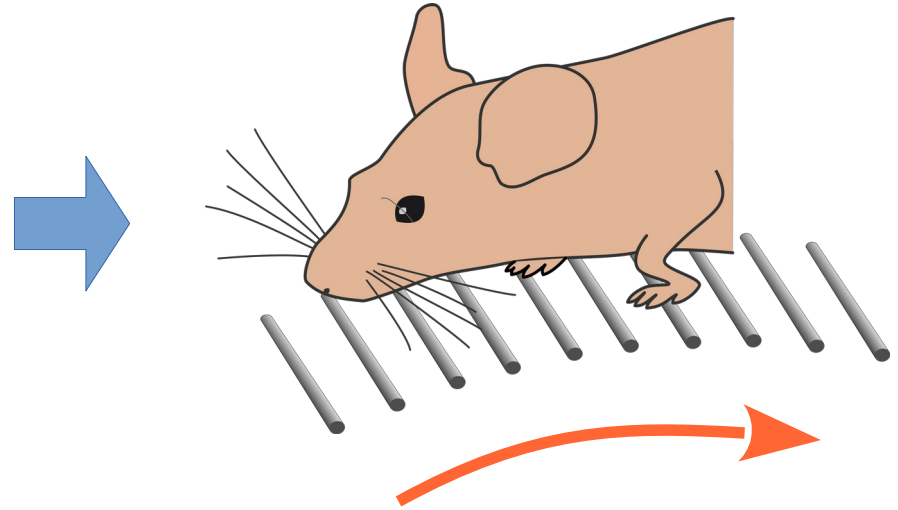

Task to study coordination on cellular level

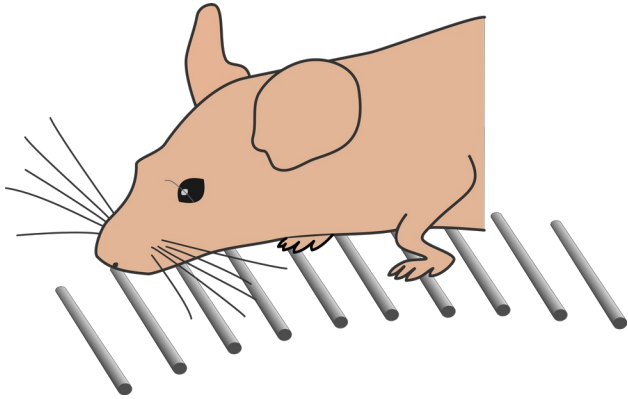

1) Acquisition of a complex motor task

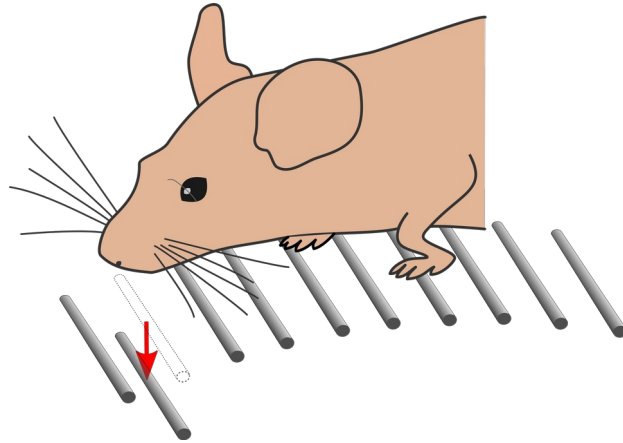

2) Adaptation to sudden environmental change

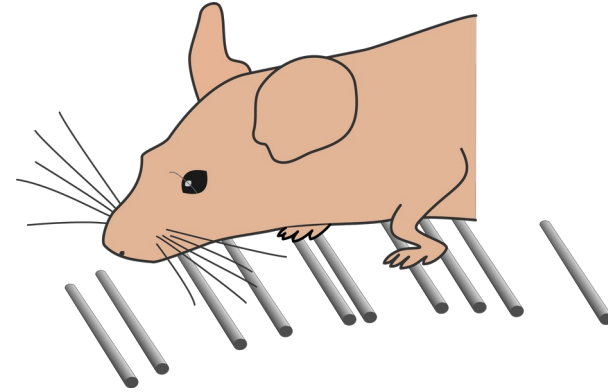

3) permanent changes of the motor plan in an irregular environment

Questions

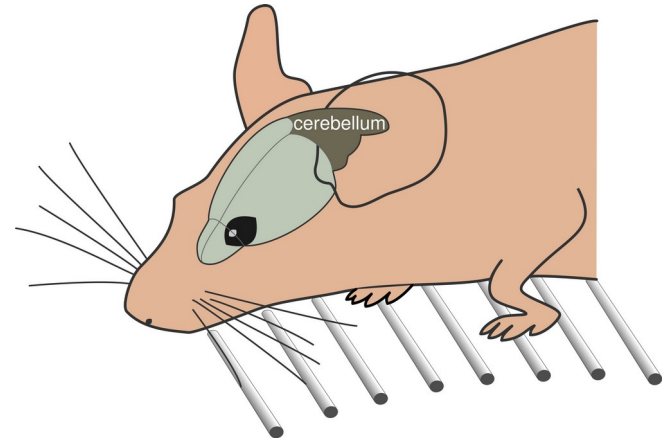
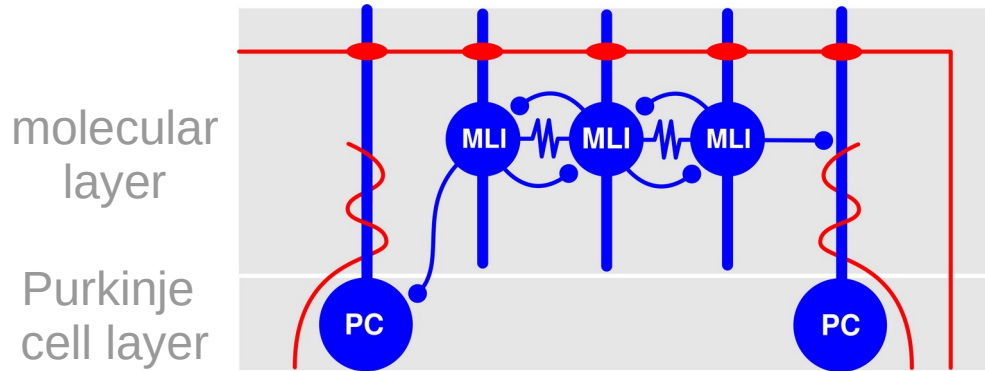

- (1.) Which activity patterns occur in the interneuron network *in vivo* ?
- (2.) What is the spatial spread of inhibition ?
- (3.) How is the activity in the interneuron network linked to motor behavior?

→ What is the link between microcircuit connectivity, activity regimes and the role in motor behavior ?

Experimental methods and setup

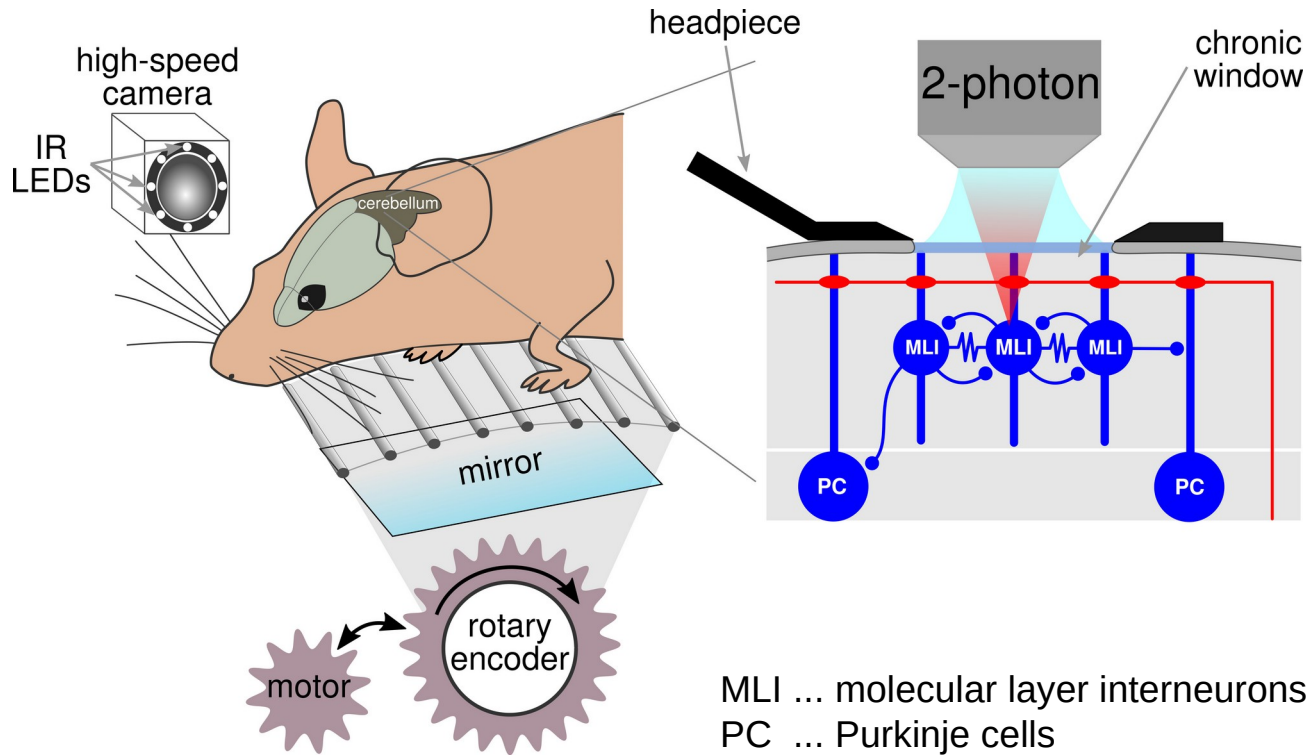

- calcium imaging from MLIs
- lobule IV/V in Vermis
- mice : reporter GCaMP6f-Tigre x promoter PV-Cre

Mouse walking on treadmill with bars (rungs)

[video]

Extraction of paw trajectories with DeepLabCut

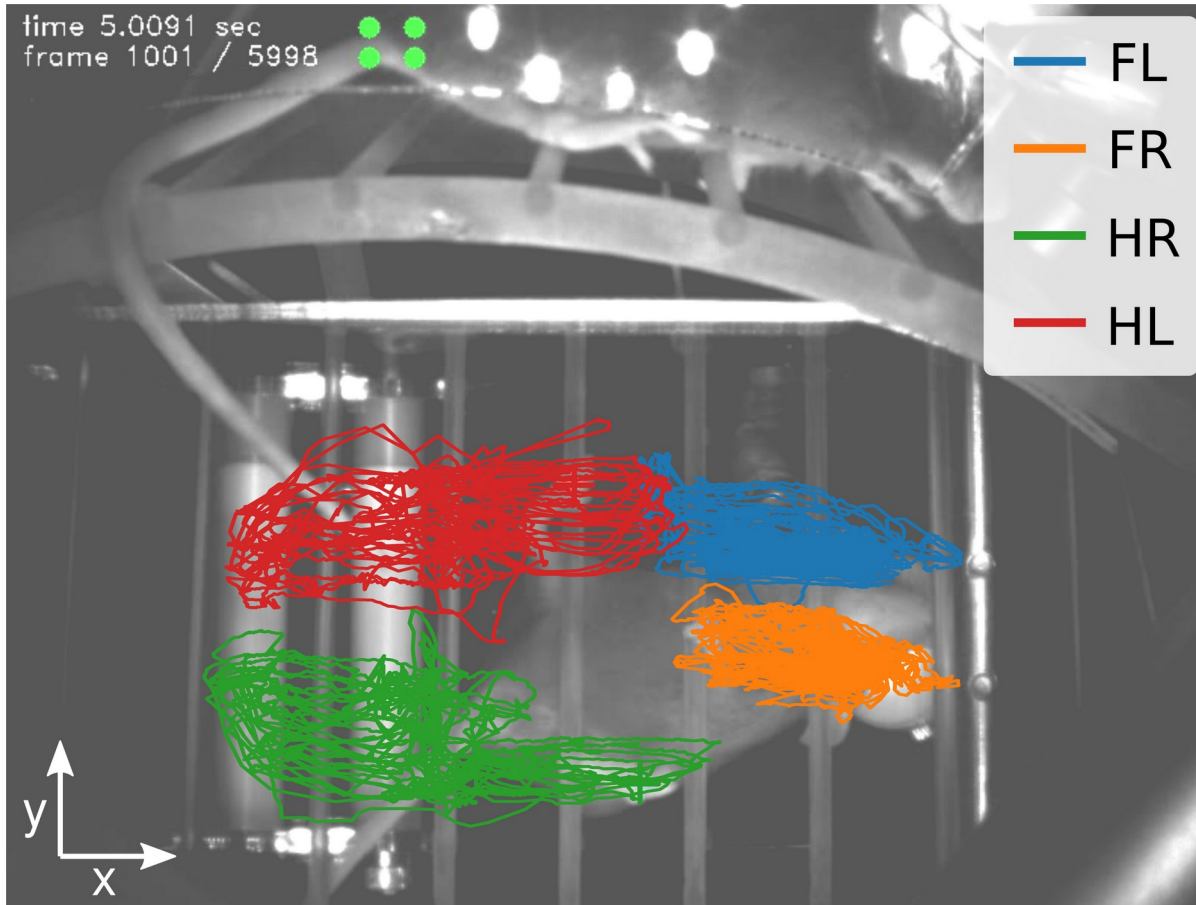

[Mathis et al. Nat Neurosci 2018]

Question: Link btw. calcium activity and locomotion?

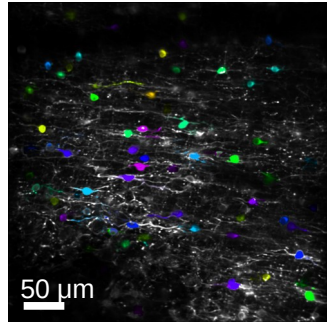

Recording

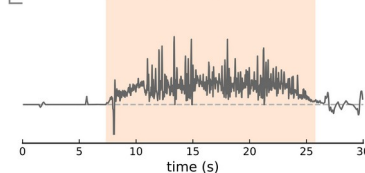
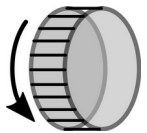
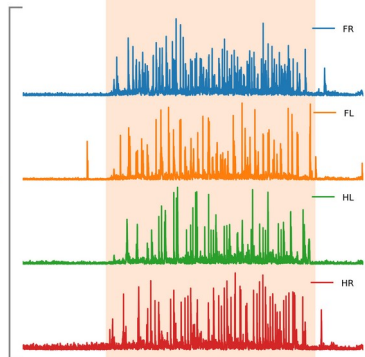
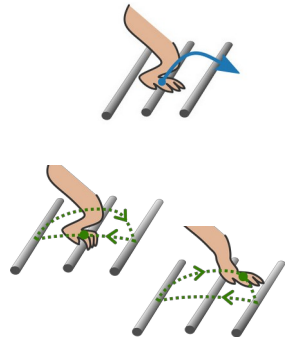
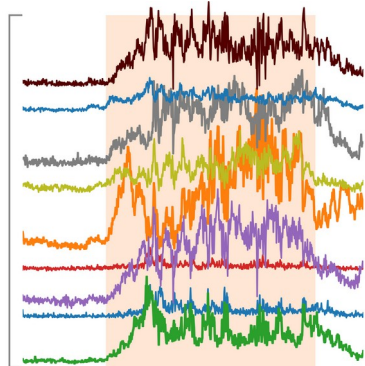

Calcium imaging data:

- reflecting activity of a local MLI network (30 Hz, GCaMP6f)
- 60 – 120 ROIs recorded simultaneously

Paw trajectories → speed:

- reflecting activity of multiple muscle groups of different angles linked to specific joint (200 Hz, high-speed video recording)
- segmented in stance and swing phases

Wheel speed:

- reflecting overall locomotion state involving multiple limbs (40 kHz, rotary encoder)

Talk outline

1. Cerebellar disorders

- functions inferred from symptoms
- eye-arm movement coordination with prism glasses

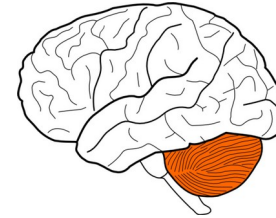

2. Electric fish and prediction of sensory consequences

- anatomy and physiology of the weakly electric fish
- cerebellar circuitry
- cerebellum-like structures
- electric fish and prediction of sensory consequences

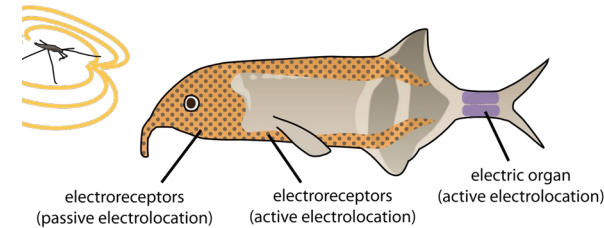

3. Movement prediction and forward model

- sensory prediction in monkeys
- forward model and the cerebellum

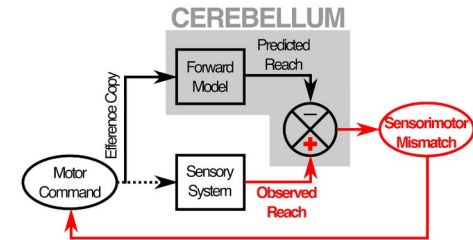

4. Experiments implemented in the lab to unravel cerebellar function

- whisker virtual reality
- learning and adaptation in complex locomotion task

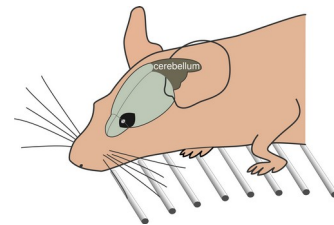

Evolution of paw trajectories over learning sessions

stride speed histogram

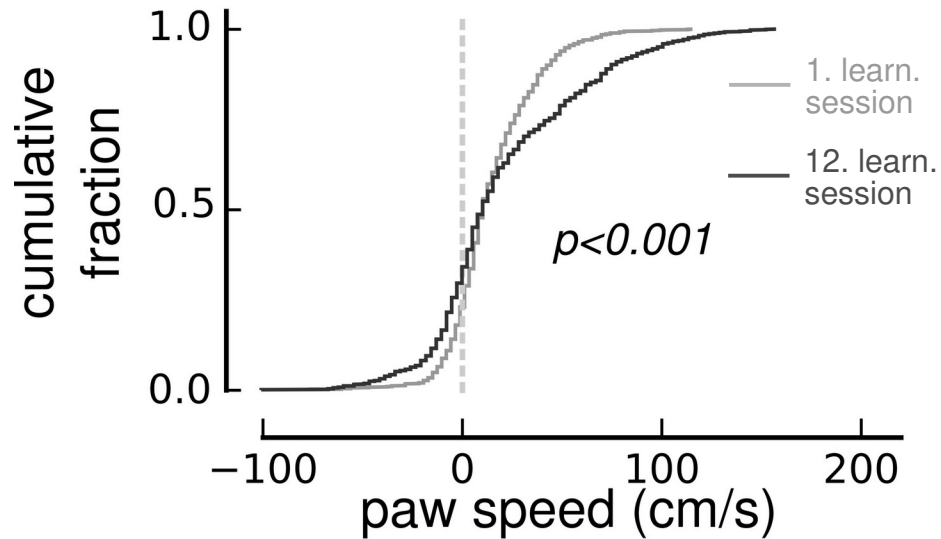

number of rungs crossed with single stride

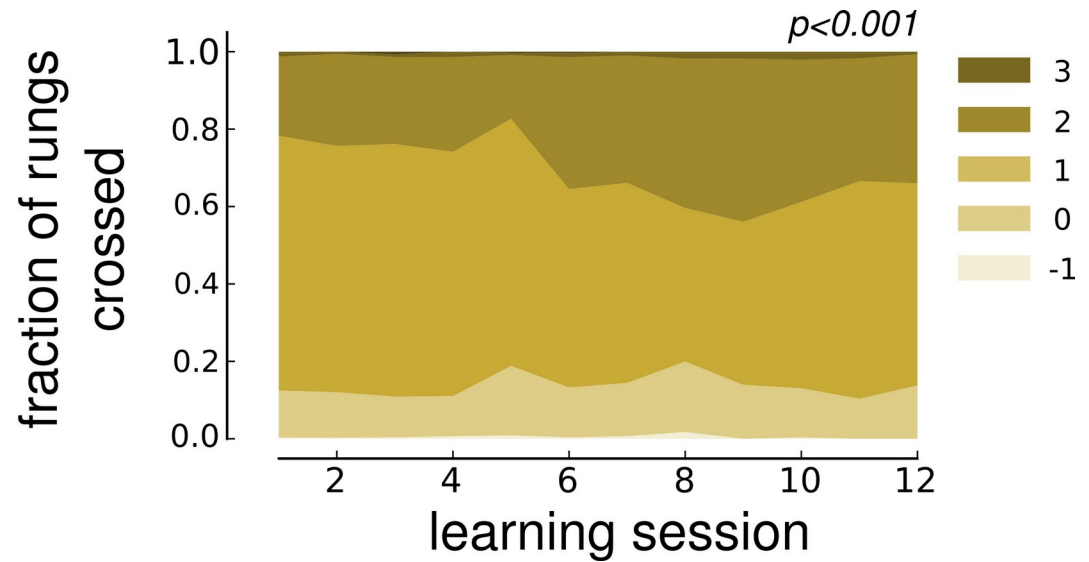

example : FrontLeft paw

Interneurons exhibit locomotion related activity

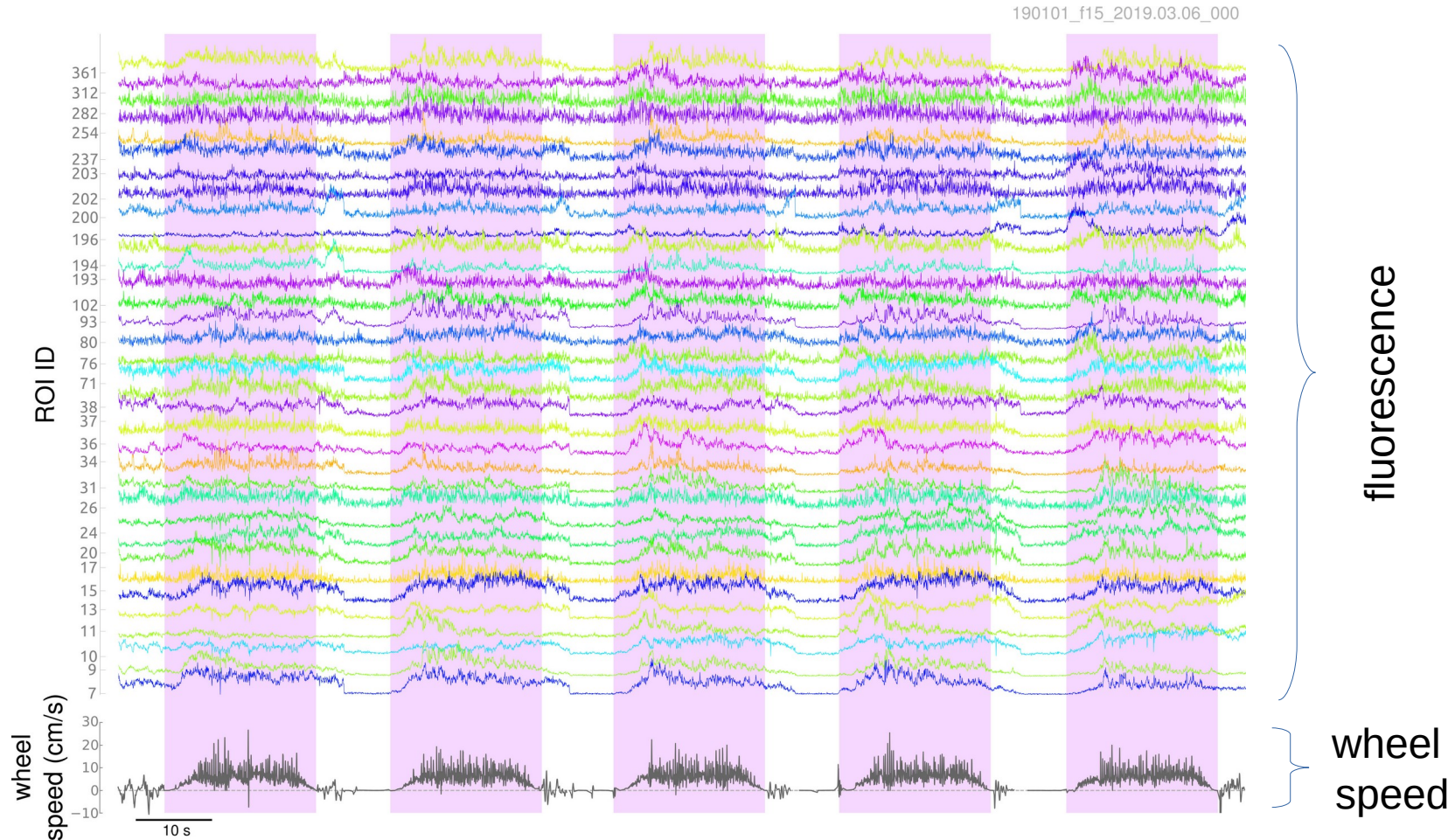
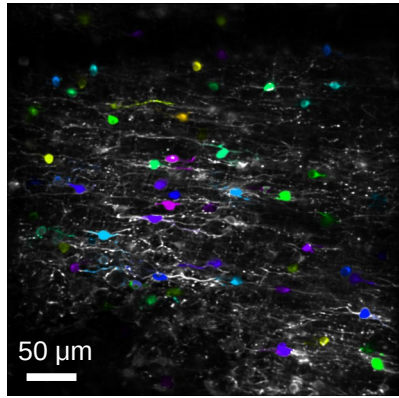

Linking individual paw movement with neural activity

paw trajectories/speed
stride length/precision

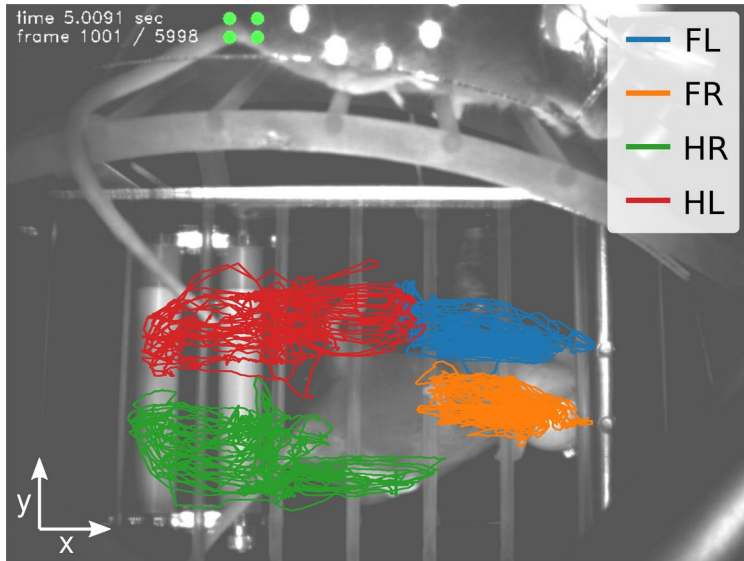

?

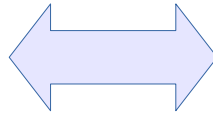

activity of interneuron
population

